

ROBERTS

Sound for Generations

WM-202

DAB/FM WiFi Internet Radio with MP3/WMA Media Streaming

with Enhanced User Interface



DAB

Digital Audio Broadcasting

Please read this manual before use

Contents

Your radio	2-8
WM-202 Internet Radio and Media Player features	2
Before you can use this product.....	3
About this instruction manual	4
Controls and connections.....	5-6
Battery operation	7
Navigation controls.....	8
Network configuration	9-16
Connecting your radio to your computer network.....	9-13
Entering your network details manually.....	14-16
Internet Radio mode	17-30
Internet Radio - the basics	17
Operating your radio - Internet Radio mode.....	18-26
Selecting a radio station by location.....	18
Selecting a radio station by genre	20
Searching for a radio station by name.....	21
Selecting a new or popular station	22
Selecting a podcast / BBC Listen Again.....	23
Presetting stations - Internet Radio	24
Last Listened	25
Display modes - Internet Radio	25-26
Customising your radio.....	27
Configuring My Favourite Stations	28
Configuring My Added Stations	28
Selecting favourite stations	29
Selecting your added stations	30
Media Player mode	31-40
Using Windows Shares	31
Locate the shared audio files using the radio	32-33
Setup a windows PC via UPnP server	34
Connecting the radio using UPnP	35
Locating and playing media files using UPnP	36-37
Media selection	38-39
Controlling playback.....	39
Display mode - Media Player	40
DAB mode	41-48
Selecting a station - DAB	42
Secondary services - DAB	42
Display modes - DAB	43-44
Finding new stations - DAB	45
Manual Tuning - DAB	46
Dynamic Range Control settings - DAB	47
Station order setup - DAB	48
FM mode	49-54
Manual tuning - FM	50
Display modes - FM	51
Scan setting - FM	52
Stereo / Mono switching - FM	53
Presetting stations - DAB and FM	54
Clock and Alarms	55-63
Automatically updating the clock	55
Setting the clock format	56
Manually setting the clock	57-58
Setting the alarm clock	59-61
Disabling alarms	62
Snooze timer	62
Sleep timer	63
Display and Audio	64-66
Brightness control.....	64
Contrast / viewing angle control	65
Headphone socket	66
Auxiliary input socket.....	66
Information	67-72
Factory reset	67
Software update	68
Network profiles.....	69
Troubleshooting	69-70
Software version display	71
Audio FAQ	71
Cautions / Specifications	72
Guarantee	74

The Roberts WM-202 provides the following features in an attractive compact unit:-

- Listen to local, regional, national and international broadcasts using FM, DAB and Internet radio
- Listen to over 1000 radio stations from around the country, and over 10,000 from around the world via the internet without using your PC.
- Listen to previously broadcast material from the BBC (using Listen Again)
- Listen to podcasts from a wide range of broadcasters.
- 15 radio station presets (5 Internet Radio, 5 DAB and 5 FM).
- Use the Media Player to play your music collection from your computer.
- The Media Player can connect to Windows Shares or UPnP servers (e.g. Windows Media Player 11). Connection to Apple and Linux based computers is also possible.
- MP3, WMA and Real Audio formats are supported.
- The WM-202 connects to your home computer network, either using WiFi or via a wired Ethernet connection.
- All radio station presets, network configuration details and user settings are retained in the event of a power failure.
- Large clock display with time and date when in Stand-by.
- Two alarm timers with snooze feature to wake you to either buzzer or radio alarm.
- Adjustable sleep timer, can be set to turn the radio off between 15 and 120 minutes.
- Easy-to-read graphic display.
- Adjustable display backlight.
- Auxiliary input for playing audio from MP3 players or other audio equipment.
- A standard 3.5mm headphone socket for private listening.
- High quality full-range, stereo speakers (2 x 3W).
- Mains or battery power (requires 6 x D cells for use away from the mains supply).

Before you can use this product

Before you can use your Internet radio, you must have the following:

- A broadband Internet connection (not required for DAB, FM or Media player functions).
- A wireless access point (WiFi) or a wired Ethernet connection connected to your broadband Internet Service Provider, preferably via a router. In many cases the broadband modem, router and wireless access point will be a single combined unit supplied by your Internet Service Provider or bought from a computer store.
- If your wireless network is configured to use Wired Equivalent Privacy (WEP) or WiFi Protected Access (WPA/WPA2) data encryption then you need to know the WEP or WPA key used for encryption so you can get the Internet radio to communicate with the network.

If connecting using WiFi, the Internet radio will typically work within a 10-20 metre radius from your wireless access point. The actual range achieved will depend upon the building type, other nearby wireless networks, and possible interference sources. DAB and FM radio functions can operate wherever the radio is able to receive a suitable broadcast signal.

IMPORTANT: Before you continue, make sure that your wireless access point or router is powered up and working with your broadband Internet service (use your computer to verify this). To get this part of the system working you must read the instructions supplied with the wireless access point or router.

This instruction manual is split into sections for each of the different operating modes of your Roberts WM-202 radio. There are four main sections - Internet Radio, Media Player (streaming files from a stored library), DAB radio and FM radio. Each section is clearly identified by the shaded heading in the top right hand corner of each pair of pages.

Before using the Internet Radio and Media Player functions, you will need to connect your radio to your computer network using either the WiFi or Ethernet connection. This is covered in the section titled **Configuration**.

The **Internet Radio** section describes how to find radio stations to listen to. These can be radio stations that you already know and listen to conventionally, or new stations you may search for. You may set up stations that you like as Favourites so that they are more readily accessible.

The section for the **Media Player** describes the two methods by which the radio can access music files that you may have stored on a computer connected to your network. The use of Shared Folders, or Shared Media (using UPnP) is explained.

The two sections for **DAB Radio** and **FM Radio** describe how to use the radio to listen to conventional radio broadcasts.

The section titled **Clock and Alarms** describes the different ways by which the clock in the radio may be set, as well as explaining the use of the alarms, snooze and sleep timer features.

The **Display and Audio** section shows how to adjust the display and to connect your radio to other equipment.

The **Information** section includes troubleshooting, specifications and warranty information.

Configuration

(page 9)

Internet Radio

(page 17)

Media Player

(page 31)

DAB Radio

(page 41)

FM Radio

(page 49)

Clock and Alarms

(page 55)

Display and Audio

(page 64)

Information

(page 67)

Controls and connections

(Top)

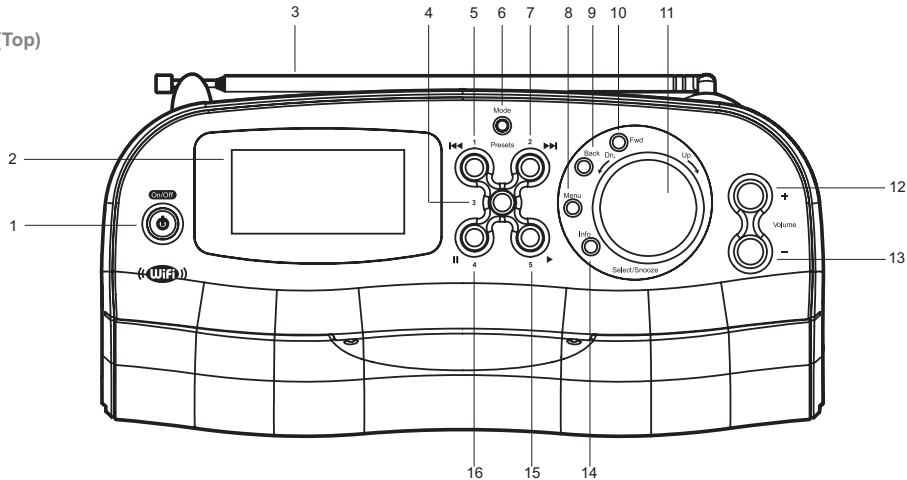

1. On / Off button

2. LCD display

3. Telescopic aerial

4. Preset button 3

5. Preset 1 / Rewind button

6. Mode button

7. Preset 2 / Fast forward button

8. Menu button

9. Back button

10. Forward button

11. Tuning / Select / Snooze control

12. Volume Up button

13. Volume Down button

14. Info button

15. Preset 5 / Play button

16. Preset 4 / Pause button

(Rear)

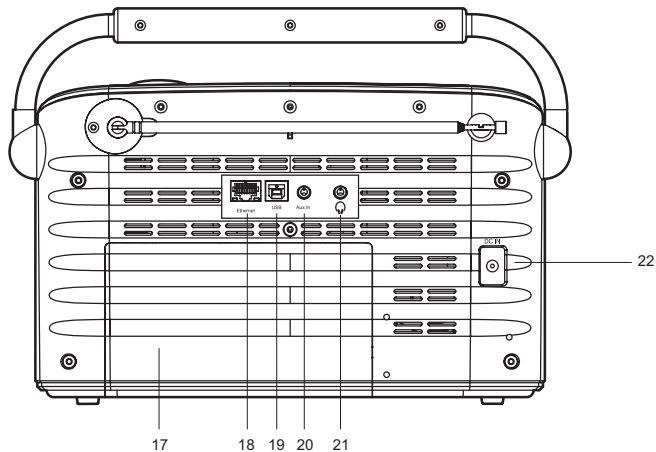

- 17. Battery compartment
- 18. Ethernet socket (RJ-45)
- 19. USB socket

- 20. Auxiliary input socket
- 21. Headphone socket
- 22. DC input socket

Battery operation

1. Remove the battery cover on the rear of the unit by pushing the battery door in slightly and then downwards in the direction of the arrows in the diagram.
2. Insert six LR20 (D size) alkaline batteries into the battery compartment. Take care to ensure all batteries are inserted with the correct polarity as shown inside the battery compartment. Replace the battery cover.
3. Short running time, reduced power, a dim display, and audio distortion are all signs that the batteries may need replacing.
4. If the radio is not to be used on battery power for an extended period of time it is recommended that the batteries are removed from the radio.

We recommend for economy that the WM-202 is used with the AC adaptor whenever possible with battery operation for occasional or stand-by use only. Inserting the adaptor plug into the DC IN socket will disconnect the batteries.

If using batteries, only alkaline types should normally be used. Battery life will vary according to the use of the radio, but between 35 and 50 hours should be possible. WiFi use takes more power than DAB listening, for example.

Rechargeable Nickel Metal Hydride (NiMH) cells can be used in the radio but must be charged outside the radio using an external charger. Note that commercially available D size NiMH cells have a capacity which is only a small fraction of that of D size Alkaline cells and so they will power the radio for only a few hours before needing recharging. *Never mix batteries of different types, capacities or brands in the radio.*

IMPORTANT: *The batteries should not be exposed to excessive heat such as sunshine, fire or the like. After use, disposable batteries should if possible be taken to a suitable recycling centre. On no account should batteries be disposed of by incineration.*

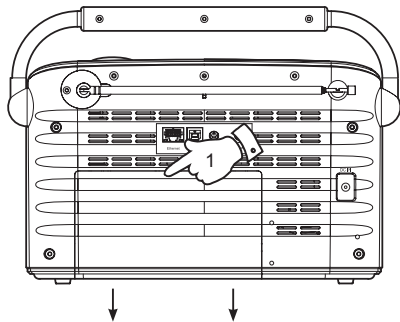

Navigation controls

This page describes the basic means of controlling your WM-202 radio. Instructions for each of the operational modes are given in the later sections of this book.

1. Pressing the **On/Off** button brings your radio out of Stand-by mode if running from the mains or switches it on if using batteries.

Pressing **On/Off** while the radio is in use will put it into Stand-by mode when running from the mains, or will switch it off after a short delay when running on batteries (alarms cannot be used when running on batteries).

2. Pressing the **Mode** button gives you access to each of the operating modes in sequence - Internet Radio, Music Player, DAB radio and FM radio.
3. Pressing the **Menu** button will access the menu system.

4. Many operations require the user to make a selection from the menu. This is done using the **Tuning/Select** control. Turn the control clockwise or anti-clockwise to highlight the desired menu item then press the control to select that item.

If there are more than five items in a menu, then the display will automatically scroll up or down so that the additional items become visible. A sliding bar on the right will give an indication showing the current portion of the menu that is displayed.

If there are many items in a menu, then the radio allows the menu to 'wrap around' in either direction. This can make it easier to reach items at the end of a long menu, such as a list of countries or Internet radio stations.

5. The **Forward** button may also be used to make selections from the displayed menu or to select the next character in text entry screens.
6. If an error is made when navigating the menus, it is generally possible to go back to a higher level menu by pressing the **Back** button.

Note: In this instruction booklet, press always means **press and release**.

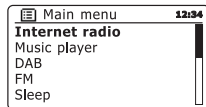
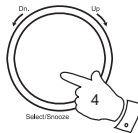
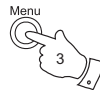
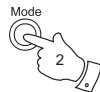

Connecting your radio to your computer network

1. Place your radio on a flat surface and plug the cable from the mains adaptor into the **DC input socket** located on the rear of your radio (marked 'DC in') ensuring that the plug is pushed fully into the socket.
2. If you wish to use a wired network connection, plug the Ethernet cable into the RJ-45 socket at the back of the radio.

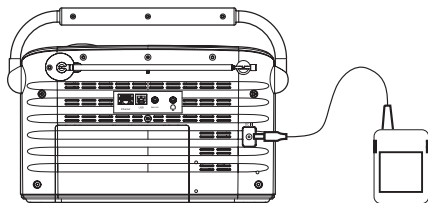

3. Plug the mains adaptor into a wall socket and switch on the socket.
IMPORTANT: The mains adaptor is used as the means of connecting the radio to the mains supply. The mains socket used for the radio must remain accessible during normal use. In order to disconnect the radio from the mains completely, the mains adaptor should be removed from the mains socket outlet completely.

4. When you apply power, the display on the radio will light up and say: 'ROBERTS' and 'STARTING' with a progress indicator. The first time that you use your radio (or after a Factory Reset) after a few seconds the display will show a default date and time of 00/00/0000 and 00:00.



5. Press the **On/Off** button to take your radio out of stand-by. You should see the main mode menu. Use the rotary **Tuning/Select** control to point to "Internet Radio" and then select this function by pressing the control.

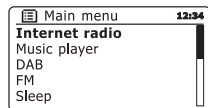
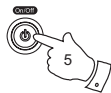

If no network connection is yet configured, the radio will enter the Network Settings Wizard and will display 'Scanning...'. After a short while the display will show a list of the available WiFi networks. If you are intending to use the WiFi connection, go to step 6.

To use the Ethernet connection to your router with automatic configuration, rotate the **Tuning/Select** control to point to the '[Wired]' menu item. Press the control and the radio will attempt to connect.

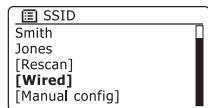
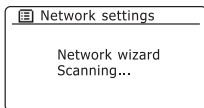

If your network allows automatic configuration the radio will acquire a network address, and will then enter the main Internet Radio menu (paragraph 13 overleaf).

There are two indicator lights incorporated into the RJ-45 connector. If you have problems with your wired connection, they may help you to identify the possible cause of the problem.

Green ON = Link established; OFF = no connection

Yellow Flashing = Data transfer

If your network does not support automatic configuration or if you wish to set it up manually then you should select '[Manual config]' instead of selecting '[Wired]' in the Network Wizard (see page 14 for more information).

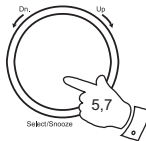

- If you wish to use a WiFi connection, you will first need to identify your network in the list of network names presented by the Network Wizard. If the radio cannot find any networks then you will have to get your wireless router working (please see the instructions supplied with it) or you may be too far from the router.

When the radio finds your wireless network, it displays the Network Name (SSID) for the wireless access point on the screen. This is a name that is allocated to the access point in your router by the person who set up the network - for example: 'Jones family' or 'Paul's network'.

It is possible, and in some locations highly likely, that your radio will find more than one wireless network, in which case you should choose which one you need to connect to.

- Rotate the **Select** control to see the SSID for each wireless network that the radio has found. If your network is shown proceed to step 9 on the next page. If it is *not* shown then proceed to step 8.

If you make a mistake at any point, use the Back option to go back to the previous screen.

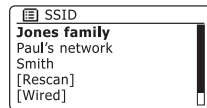
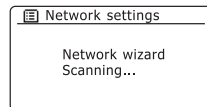
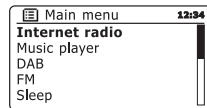

Connecting to your computer network - cont.

8. If your network is not found, it is possible that it is configured such that the SSID is not broadcast (sometimes referred to as hidden). If this is the case then the name will not be visible in the list (there may be a blank entry). You will then need to use the **Tuning/Select** control to point to the '[Manual config]' option, and then you should press the control to enter manual configuration. This procedure is described in the 'Network Configuration Menu', see page 14, 'Entering the network name manually'.

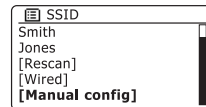
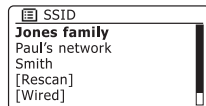
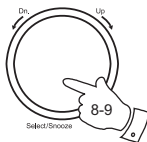

9. When the SSID for the wireless network you wish to connect to is highlighted on the screen, press the **Tuning/Select** control.
10. If your network is configured without an encryption code, the screen should say 'Connecting...', and then show the main Internet Radio menu.

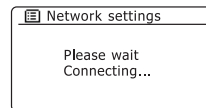

If this is the case then you have successfully connected your radio to your network, so please proceed to paragraph 13 on the next page.

11. If the screen displays 'Key:', it is because the network is using one of the encryption systems: Wired Equivalent Privacy (WEP) or WiFi Protected Access (WPA). You therefore need to enter the correct WEP or WPA key into the radio to allow it to communicate with your wireless network.

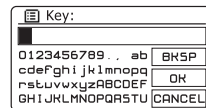

If you do not have the WEP or WPA key, then you should obtain it from the person who set up your network. Some wireless routers may come with an encryption key already set up by the supplier, in which case you should refer to the user documentation provided with it.

WEP keys are 10 or 26 characters long (using 0 - 9, and A - F). Some wireless routers can also use pass-phrases for WEP but these do not conform to a defined standard and are not supported. WPA keys are usually set up using a pass-phrase of between 8 and 63 characters. Your Internet radio can accept pass-phrases for WPA keys.



- To enter the WEP or WPA key, characters are selected and entered using the **Tuning/Select** control. As you rotate the control, the radio scrolls through the available characters as well as the three controls on the right. The character currently highlighted will be entered when you press the **Tuning/Select** control.

Do this as needed until the complete key has been entered. *Remember, WEP keys only use the numbers 0-9 and letters A-F. WPA keys are sensitive to upper and lower case characters. You must enter the key **exactly** or the radio will not connect to the network.*

The three controls on the right-hand side of the screen have special functions. You can quickly access these by pressing the **Info** button and then use the **Tuning/Select** control as needed:

- select '**BACKSP**' to erase a character or key previously entered
- select '**OK**' when the key is complete
- select '**CANCEL**' to cancel and re-run the Network Wizard

If a WEP or WPA key has previously been entered for the selected SSID then the display will show 'Key: [Set]'. If you have previously entered a different key, you must clear this by selecting the **BACKSP** symbol. This will remove the '[Set]' indication.

After the final character of the WEP or WPA key has been entered, highlight the **OK** symbol and press the **Tuning/Select** control. The radio should now be able to connect to the network.

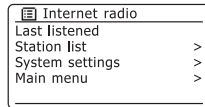
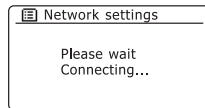
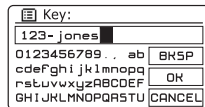

- Once you have connected your radio to the network (and therefore also to the Internet) it will display the main Internet Radio menu. Press the **On/Off** button to put the radio in Stand-by mode. It should then display the time. This time is obtained from the Internet by the radio. If the time display is not correct for any reason, it can easily be adjusted later, see page 57, 'Manually setting the clock'.

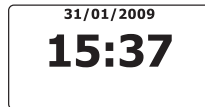

Connecting to your computer network - cont.

If you have followed the steps on the preceding pages successfully, your radio will have connected to your router, and then made a connection to the Internet and set its clock. If this is the case, then you can try listening to radio stations via the Internet as described on page 17 onwards.

Changing the network connection

In the sections above, you chose how your radio would be connected to your network, either using a WiFi connection or using a wired Ethernet cable. From time to time, you may find that you need to connect to different computer networks. The Internet setup menu allows you to change your radio's network settings, scan for an alternative wireless network, or to manually configure the network parameters.

The steps outlined below describe how you can do this - see also the section 'Network profiles' on page 69. If you have no need to do this, however, please skip to page 17.

Configuring the radio to use an alternative WiFi connection

1. From the radio's Network settings menu, select 'Network wizard'. This will present you with details of any WiFi networks that are found. Scroll down the list using the **Tuning/Select** control to the desired network name. Press the control to select this network.

The radio will then use its WiFi system to communicate with the network. Depending on the settings for that particular network you may need to enter an encryption key (see page 11). By default the radio will then acquire an IP address and other network settings from your router using DHCP.

Configuring the radio to use the wired Ethernet connection

2. Connect your radio to your router using an Ethernet cable plugged into the RJ-45 socket at the back of the radio. From the radio's Network settings menu, select 'Network wizard'. This will present you with details of any WiFi networks that are found. Scroll down the list using the **Tuning/Select** control to the '[Wired]' option. Press the control to select this.

The radio will then use its Ethernet connection to communicate with the network. By default the radio will then acquire an IP address and other network settings from your router using DHCP.

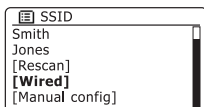
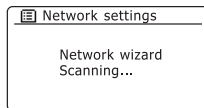
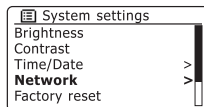
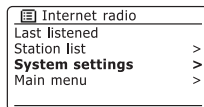

Entering the network details manually

If you do not wish to use DHCP for automatic configuration, or if your network is configured with a hidden SSID, then you will need to enter some network settings manually. (Note - a hidden SSID may prevent casual observers from detecting your network, but it is not recommended as a means of network security.)

- From the radio's Network settings menu, select 'Manual settings'. You must then choose whether to connect using 'Wired' or 'Wireless' connections. If you choose 'Wireless' there are as many as nine settings screens, shown by the '1 of 9' progress marker in the top right corner of the display. If you choose 'Wired' there are five screens and the progress marker will reflect this, although the steps to set up the network parameters are basically the same.

- The next menu asks whether you wish to use DHCP to configure your network parameters (IP address, subnet mask, gateway address, etc.). Unless you are familiar with networking and related terminology, we recommend that you allow the use of DHCP. Choose 'DHCP enable' unless you need to specify network details manually.

If you have chosen 'Wired' and then 'DHCP enable', your radio should now establish a connection to the router using the Ethernet cable. Please skip to step 11 on page 16.

If you chose 'Wireless' and 'DHCP enable', please skip to step 6 on page 15 in order to set up the wireless connection details.

If you chose 'DHCP disable' for either connection method, the next step is to set up the IP address.

- The IP address used should be chosen to be compatible with the settings in your router and must be a unique address on your network. If you are using DHCP for some devices and static (manually configured) IP addresses for others, the IP address used should fall outside the range that the router may allocate using DHCP. Typically, the first three groups of digits will be the same for all devices on your network. To enter the IP address, rotate the **Tuning/Select** control to set the value for each group of digits and then press the control to enter the value and to move on to the next group. When the IP address has been entered, the subnet mask should be entered. The subnet mask defines which parts of the IP address are common across your network. For most small networks the subnet mask will be 255.255.255.0 and this is entered in the same way.

- The Gateway address is normally the IP address of the router through which the radio connects to the internet and is entered in the same way as the previous addresses.

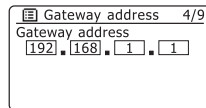
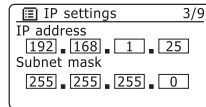
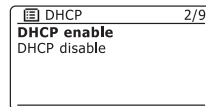
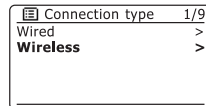
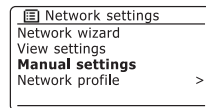

Entering the network details manually - cont.

5. In most installations the DNS settings (DNS = Domain Name Server) will be set to the same IP address as your router. In this case the secondary DNS may be left at zero.

To enter the DNS address, rotate the **Tuning/Select** control to set the value for each group of digits and then press the control to enter the value and to move on to the next group. Repeat this until all eight groups of digits have been entered.

If you previously specified 'Wired' and then 'DHCP disable', your radio should now connect to the router using the Ethernet cable (in which case skip to step 11).

6. If you specified 'Wireless', the next step is to set up the WiFi connection, starting with the name of the wireless network (SSID) followed by the encryption options and password.

To enter the SSID, characters are selected and entered using the **Tuning/Select** control. As you rotate the control, the radio scrolls through the available characters as well as the three controls on the right. The character currently highlighted will be entered when you press the **Tuning/Select** control.

Do this as needed until the complete network name has been entered. *The SSID setting is sensitive to upper and lower case characters and symbols. You must enter it exactly as set up in your router.*

The three controls on the right-hand side of the screen have special functions. You can quickly access these by pressing the **Info** button and then use the **Tuning/Select** control as needed:

- select '**BKSP**' to erase a character or key previously entered (press **Info** again to continue)
- select '**OK**' when the SSID is complete
- select '**CANCEL**' to cancel and go back to the DNS settings screen

7. Having entered the SSID, you must enter details of the encryption system used on your wireless network. This should be the same as specified in your router settings. If your network does not use encryption, then select the 'Open' option. Your radio should then connect to the network - skip to step 11. If your network uses WEP (Wired Equivalent Privacy) select the 'Pre-Shared Key' option then go to step 8. The remaining options are for WPA or WPA2 (WiFi Protected Access) - see step 9.

8. If you chose 'Pre-Shared Key' in step 7, you should then choose the WEP option. The key should be entered using only the numbers 0-9 and the letters A-F. The key will be 10 characters long for 64-bit encryption and 26 characters long for 128-bit encryption. The radio will accept lower-case letters a-f as equivalent to upper-case A-F. Spaces or special symbols are not permitted in WEP keys.

 DNS	5/9
Primary DNS	
[192] [168] [1] [1]	
Secondary DNS	
[0] [0] [0] [0]	

 SSID	6/9
mynetwork	
0123456789 . , ' ab	BKSP
cdeFgh i j k l m n o p q	OK
r s t u v w x y z A B C D E F	CANCEL
G H I J K L M N O P Q R S T U	

 Authentication	7/9
Open	
Pre-Shared Key	
WPA	
WPA2	

 Encryption type	8/9
Disabled	
WEP	

 Key:	9/9
01234ABCDE	
0123456789 . , ' ab	BKSP
cdeFgh i j k l m n o p q	OK
r s t u v w x y z A B C D E F	CANCEL
G H I J K L M N O P Q R S T U	

Entering the network details manually - cont.

The three controls on the right-hand side of the screen have special functions. You can quickly access these by pressing the **Info** button and then use the **Tuning/Select** control as needed:

- select '**BACKSP**' to erase a character or key previously entered (press **Info** again to continue)
- select '**OK**' when the encryption key is complete
- select '**CANCEL**' to cancel and go back to the SSID settings screen

Once the key is entered the radio should connect to your network. Please skip to step 11.

9. WPA and WPA2 are similar, although WPA2 offers a higher level of security. Whichever you selected in step 7, you then have to specify the variant used. They are TKIP (Temporal Key Integrity Protocol) and AES (Advanced Encryption Standard). As previously, the setting should match that used by your router. Some routers allow both to be specified, and the router will use whichever variant is supported by the connected device. AES is regarded as the more secure option if it is available.

10. The radio will then require you to enter the encryption key. This must be a string of between 8 and 63 characters and must be identical to the key which has been entered into your router. *Note - the encryption key is sensitive to the use of upper and lower case letters and symbols. Take care to enter the key exactly, or the radio will not be able to connect to your router.*

The three controls on the right-hand side of the screen have special functions. You can quickly access these by pressing the **Info** button and then use the **Tuning/Select** control as needed:

- select '**BACKSP**' to erase a character or key previously entered (press **Info** again to continue)
- select '**OK**' when the encryption key is complete
- select '**CANCEL**' to cancel and go back to the TKIP / AES options screen

Once the key is entered the radio should connect.

11. While the radio is trying to connect to your network, it will display 'Processing...' while checking the encryption key (if using the WiFi connection) and then 'Connecting...'. If the connection is made successfully, the radio will return to the Network settings menu. If the radio cannot connect, then it will display a 'Failed to connect' message and will return to the SSID entry screen (step 6).

Once connected, the network settings are stored in the radio. The settings are retained when the radio is disconnected from the mains and when batteries are removed.

You may now use the **Back** or **Mode** buttons to access the functions of your radio.

Authentication	7/9
Open	
Pre-Shared Key	
WPA	
WPA2	

Encryption type	8/9
TKIP	
AES	

Key:	9/9
A Key For My Network	
0123456789 . _ ! @ # \$ % & ' () * + , - : ; < = > ? [\] ^ _ ` { } ~	BACKSP
OK	OK
GHIJKLMNOPQRSTU	CANCEL

Network settings
Please wait Connecting...

Network settings
Network wizard
View settings
Manual settings
Network profile >

Internet Radio mode

Internet Radio - the basics

Before you can use your radio to listen to broadcasts via the internet, it is necessary to have already connected your radio to your computer network using either the wireless (WiFi) connection or the wired Ethernet connection (RJ-45 socket) on the back of the radio. Please see page 9 for details.

There are literally many thousands of broadcasts available via the internet. Your radio provides several ways of searching for broadcasts in order to make finding and choosing broadcasts easier. Once you have found radio stations which you like, you may either store them as presets within the radio, or add them to a list of your favourite stations which your radio can access. The number of presets is limited (there are five preset buttons on the radio), but you can store as many favourites as you like.

You may search for an internet radio station by Location. If you know the name of the station and the country from which a station is broadcast this may be the easiest method to find a station. It is also a great way to experience radio from other parts of the world.

You may also search for an internet radio station by Genre. If you prefer a particular type of music, Blues for example, you may search for a radio station that broadcasts that type of music, and you can see a list of Blues radio stations regardless of location, or taking location into account.

If you know part of the name of an internet radio station, you can enter it into the radio and it will search for stations that match that name. This can be helpful if you are unsure of the location or genre of a particular station.

The WM-202 radio connects to a radio station database which serves many users in many countries. This means that there is a very wide range of programme content available. You can also search for stations which have been recently added to those available (new stations) or you can search for the most popular.

Selecting a radio station by location

1. Press the **On/Off** button to switch the radio on. Then press the **Mode** button to select Internet Radio mode.
2. Press the **Menu** button to enter the main Internet Radio menu. Rotate the **Tuning/Select** control until "Station list" is highlighted on the display. Press the **Tuning/Select** control to select.
3. Rotate the **Tuning/Select** control until 'Stations' is highlighted on the display. Press the **Tuning/Select** control to select.
4. Rotate the **Tuning/Select** control until 'Location' is highlighted on the display. Press the **Tuning/Select** control to select.
5. Rotate the **Tuning/Select** control to scroll through the list of continents. When the desired continent is highlighted press the **Tuning/Select** control.
6. The display will show the list of countries within the chosen continent. If there are many countries shown you can scroll through the list continually in either direction. For example, if the chosen continent was Europe, then to find the United Kingdom scroll up from the top of the list to the bottom by turning the **Tuning/Select** control anti-clockwise. Press the **Tuning/Select** control to choose the desired country.
7. You will typically find that you then have the option to select either 'All Stations' or one of a number of categories. The lists are always sorted alphabetically, and long lists will wrap around from top to bottom or bottom to top.

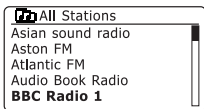
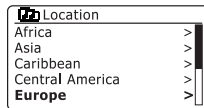
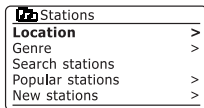
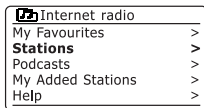
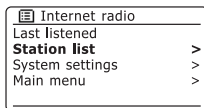
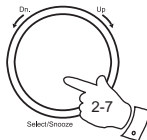

8. Rotate the **Tuning/Select** control to highlight your chosen radio station and then press the control to confirm. The display will show 'Connecting...' while the radio connects to the new station. The radio should then start playing. Adjust the volume as needed.

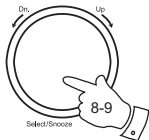

9. If the station has on-demand content, that is, it gives the option of listening to programmes which have already been broadcast or to Podcasts, there will be an additional screen showing the radio station name as well as a 'Podcasts' option.

These are selected using additional menus, determined by the radio station and the content. There may simply be a list of programmes, or there may also be options to choose from broadcasts on particular dates or days of the week. The examples shown here are typical.

Podcasts and Listen Again content can also be accessed separately from the main Internet Radio menu, see page 23.

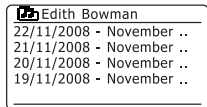
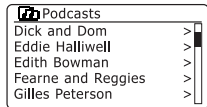
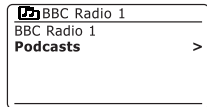
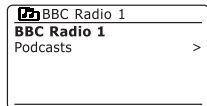

If your radio cannot connect to a radio station

Note: If your radio is unable to connect to an internet radio station it will generally either display 'Network Error' or 'Stopped'. This can be for many reasons, but typically will be due to one of the following:

The radio station may not be broadcasting at the present time.

The radio station may not be able to accommodate any more connections from internet listeners.

There may be network congestion (either locally or at a distance) which is affecting the reliability of the connection.

If your radio can connect, but the audio is not continuous and the radio keeps having to reconnect, this may be due to the radio station only having limited connection capacity.

Please also refer to the section Troubleshooting on page 69.

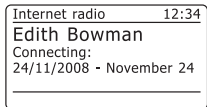

Selecting a radio station by genre

1. Press the **Menu** button to enter the main Internet Radio menu. Rotate the **Tuning/Select** control until "Station list" is highlighted on the display. Press the **Tuning/Select** control to select.
2. Rotate the **Tuning/Select** control until 'Stations' is highlighted on the display. Press the **Tuning/Select** control to select.
3. Rotate the **Tuning/Select** control until 'Genre' is highlighted on the display. Press the **Tuning/Select** control.
4. Rotate the **Tuning/Select** control to scroll through the list of content types. This menu is normally cyclic - you can scroll the list continually in either direction. When the chosen genre is highlighted, press the **Tuning/Select** control.
5. You then have the choice of 'All Stations' of the chosen genre, or a list of countries. Note if a country is not shown then the station may still appear in the 'All Stations' list. Rotate and then press the **Tuning/Select** control to choose as needed
6. A list of radio stations is then shown. Rotate the **Tuning/Select** control until the desired station name is highlighted on the display.
7. Press the **Tuning/Select** control to select the station. The display will show 'Connecting...' while it finds the new station. If the radio is unable to connect this may be for one of the reasons explained on page 19.

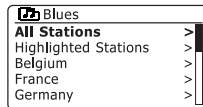
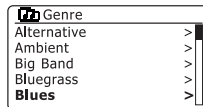
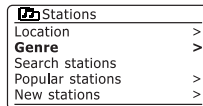
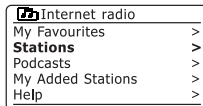
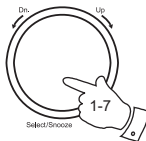

Searching for a radio station by name

There may be occasions when you know the name of a radio station but you do not know the location or genre. This facility allows you to search for the station using a part (or parts) of the radio station name.

1. Press the **Menu** button to enter the main Internet Radio menu. Rotate the **Tuning/Select** control until 'Station list' is highlighted on the display and then press the control to select.
2. Rotate the **Tuning/Select** control until 'Stations' is highlighted on the display and then press the control to select.
3. Rotate the **Tuning/Select** control until 'Search stations' is highlighted on the display and then press the control to select.
4. To enter the search word(s) rotate the **Tuning/Select** control to highlight each character for the search in turn, and press the **Tuning/Select** control to enter. If you make an error rotate the control or use the **Info** button to access the delete character '[BKSP]' on the screen and then press the **Tuning/Select** control. Rotate the control or press **Info** again to go back to the character selection. After the final character of the search has been entered, use the **Info** button and then the **Tuning/Select** control to highlight the '[OK]' symbol on the screen and then press the control to finish.
5. The radio will search for radio stations that match your search data. If you include a space between two search items the radio will look for station names which include both items. Thus a search for 'ROCK 100' could find a station called '100 Classic Rock Hits' as well as a station called '100.FM Rocks'
6. Rotate the **Tuning/Select** control to highlight the station that you wish to listen to and press the control to confirm your choice. The display will show 'Connecting...' while it finds a new station.

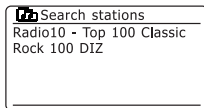
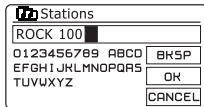
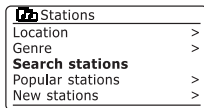
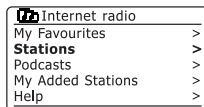
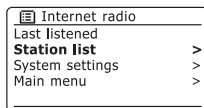
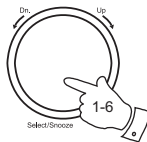

Selecting a new or popular station

As described in the section Introducing Internet Radio on page 17, your radio connects to an internet database of radio stations. This may highlight stations which are newly added to the list of those available or stations which are particularly popular with listeners around the world. Your radio allows you to easily choose stations from these two categories, using menus very similar to those used when finding stations by location and genre.

1. Press the **Menu** button to enter the main Internet Radio menu. Rotate the **Tuning/Select** control until "Station list" is highlighted on the display. Press the **Tuning/Select** control to select.
2. Rotate the **Tuning/Select** control until 'Stations' is highlighted on the display. Press the **Tuning/Select** control to select.
3. Rotate the **Tuning/Select** control until 'Popular stations' or 'New stations' is highlighted on the display. Press the **Tuning/Select** control.
4. Rotate the **Tuning/Select** control to highlight the station that you wish to listen to and press the **Tuning/Select** control to confirm your choice. The display will show connecting while it finds a new station.

If the radio is unable to connect to a particular radio station this may be for one of the reasons explained on page 19.

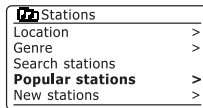
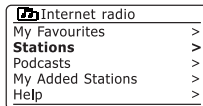
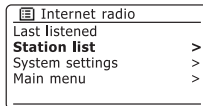
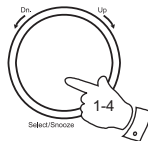

Selecting a podcast / BBC Listen Again

Some radio stations allow you to listen to programmes that have already been broadcast. The BBC's Listen Again service is an example of this. In addition, radio broadcasters and individuals may make programmes which are intended normally to be downloaded into a computer or copied onto a portable media player. These are commonly known as Podcasts.

On your radio, both Listen Again programmes and Podcasts are grouped together as Podcasts, and the same menu is used to access and listen to either type of programming. Listen Again programmes are also accessible via the 'Stations' menu (see pages 18-19).

1. Press the **Menu** button to enter the main Internet Radio menu. Rotate the **Tuning/Select** control until 'Station list' is highlighted on the display. Press the **Tuning/Select** control to select.
2. Rotate the **Tuning/Select** control until 'Podcasts' is highlighted on the display. Press the **Tuning/Select** control to select.
3. You may then search by location, genre, or using part of the name of the podcast. The searches operate in exactly the same way as when searching for a conventional radio station.
Searching by location is done first by continent, then by country. You may then list 'All shows' or search within a country by genre.
Searching by genre is more direct, since once the genre is chosen the next menu display shows a list of available podcasts.
Searching by name operates in the same way as when searching for a named radio station. You may enter one or more pieces of text which will be used for the search.

4. Rotate the **Tuning/Select** control and then press the control to confirm your chosen podcast. The display will show 'Connecting...' while it finds the new programme.

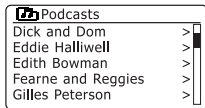
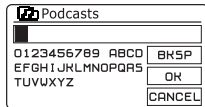
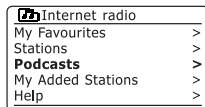
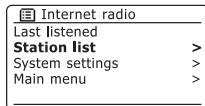
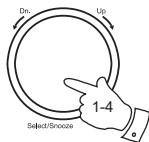
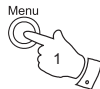

Presetting stations - Internet Radio

With so many Internet radio stations available, it is desirable to have a means of rapidly selecting the stations that you listen to most frequently. Your radio has five memory presets which can easily be set to store the details of any Internet radio station. The radio station presets are retained in memory even when the radio is switched off.

Please see also 'Last Listened' on page 25 and 'Configuring My Favourite Stations' on page 28.

Storing a preset

1. Press the **On/Off** button to switch on your radio. Tune to the required station using one of the methods described on the preceding pages.
2. To store the currently playing radio station as a preset, press and hold the required **Preset** button (1 - 5) until the display shows 'Preset stored'. The station will be stored using the chosen preset button. Repeat this procedure as needed for the remaining presets.
3. Stations which are already stored in the presets may be over-written by following the above procedure.

Recalling a preset - Internet radio

1. Press the **On/Off** button to switch on your radio. Select the Internet radio mode using the **Mode** button.
2. Momentarily press the required **Preset** button. Your radio will then connect to the station stored in preset memory. The preset used will be shown at the bottom of the display screen.

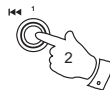

Last Listened

It is often helpful to be able to go back to a station that you have recently listened to. Your radio has a 'Last Listened' feature which provides you with quick access to the ten most recently listened to radio stations or podcasts. As each new radio station is listened to the oldest item is deleted from the list. The Last Listened list is stored when the radio is without power.

1. With the radio switched on and in Internet Radio mode, press the **Menu** button. The first item on the menu is 'Last listened'. With this item highlighted press the **Tuning/Select** control.
2. The display will then show a list of the last ten Internet radio stations or podcasts. Rotate the **Tuning/Select** control to highlight whichever you wish to listen to and then press the control to cause your radio to reconnect to that radio station or podcast.

Display modes - Internet Radio

Your radio has a range of display options when in Internet Radio mode. Note that not all information may be available for all Internet radio stations

1. Press the **Info** button to cycle through the different options.
 - a. **Description** Displays information about the radio station or scrolling text messages such as artist/track name, phone number etc.
 - b. **Genre and Location** Displays programme type information e.g. Pop, Classic, News, etc. and the location of the current radio station

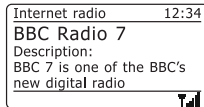
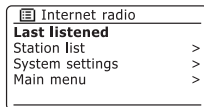
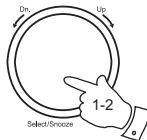
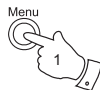

- c. Reliability Displays the reliability of the data stream from the station currently being received.

- d. Format Displays the bit rate and format of the station being received.

- e. Playback buffer Displays status when connecting to and playing a radio station. This indicates the reliability of the data stream to your radio. If there are no bars shown to the right of the dividing line then the data stream reliability is poor and you may find that there are many breaks in the audio.

- f. Date Displays the current date.

Additional or alternative information may be displayed when listening to Podcasts. Categories displayable can include...

Episode name	Show description
Show genre	Show language
Episode URL	Bit rate
Codec	Sampling rate

Whenever the radio is displaying an information screen (as opposed to a menu screen), the time is displayed in the top-right corner of the display, and a WiFi strength or Ethernet connection indicator is shown in the bottom-right corner.

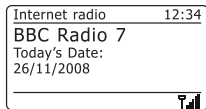
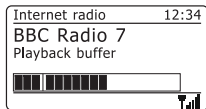
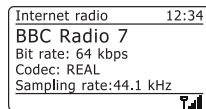
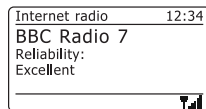

Customising your radio

In addition to storing your favourite radio stations in the radio presets, your radio allows you to create customised lists of stations which can appear in two special menus on the radio called 'My Favourites' and 'My Added Stations'.

Your radio uses a database which is accessed via the Internet in order to find out which radio stations are available and how it should connect to them. You are able to add your personal selections to this database. These will only be accessible by you using your PC or your radio. You can choose the stations which will appear in the 'My Favourites' menu from the large selection already listed. Additionally, if you find a radio station that is not listed then you may also add the Internet address (URL) of the station's audio stream to your selection. It will then appear on your radio via the 'My Added Stations' menu item.

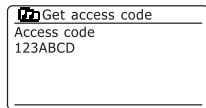
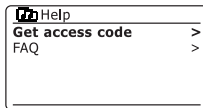
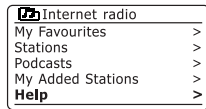
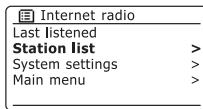

Registering an account

1. Open the web site, <http://www.wifiradio-frontier.com>, using the Internet browser on your computer. Click on the 'Register here' link and follow the on-screen instructions to register an account. Please note, during the registration process, the web site asks for an access code. This allows it to uniquely identify your radio from the many others that it also provides data for. To obtain the access code, please follow these steps.
2. With your radio switched on and in Internet radio mode, press the **Menu** button, then select 'Station list' using the **Tuning/Select** control.
3. Scroll down the Station list menu to the item called 'Help'. Press the **Tuning/Select** control to enter the Help menu.
4. In the Help menu, select the menu item 'Get access code'. Provided that the radio is connected to the Internet, a code will be displayed of typically seven characters (upper case letters and numbers). Make a note of this code for the next step.
5. You should then use the code displayed by the radio to fill in the Access Code field on the web page when you set up your account.

Once you have your account set up, if you have other radios which use the same system, you may also add them to your account. You will need to get an access code from each radio in order to add it to the account. They may then share your favourite and added radio station details.

Customising your radio - cont.

Configuring My Favourite Stations

1. Using the web site at <http://www.wifiradio-frontier.com>, it is possible to search among the many radio stations that are available by location, genre, or language. You may also choose from new or popular stations.
2. When the radio stations that you have found are shown on your computer screen, they are shown with a 'Play' icon and an 'Add to favourites' icon (the plus symbol and heart). Clicking on the 'Play' icon will allow you to hear the radio station via your computer. Clicking on the 'Add to favourites' icon will cause the radio station to be added to the list accessible via your radio.
3. To help you organise your favourites, since you may have a great many after a while, the web site will allow you to specify the name for a category or group under which the radio station will be listed on your radio. Suitable names might be 'Rock', 'Smooth', 'Mum's stations', and so on. When ever you add another radio station to your favourites you can either add it to an existing category or create a new one.
4. Once you have Internet radio stations available in your My Favourite Stations list, you may play these stations from your Internet Radio. These stations will be available on your radio from the Internet radio menu item 'My Favourites'.
5. To look at, modify or delete your favourite stations lists on the web site, use the link 'My favourites' in the 'My account' area. To delete a favourite radio station, click on the icon with a heart and minus symbol.

Configuring My Added Stations

1. If you wish to listen to a radio station which is not currently held in the database at <http://www.wifiradio-frontier.com>, it is possible to add the details yourself. You will need to obtain the internet address (URL) for the audio stream for the station that you wish to add. This may be information provided by the radio station itself, or perhaps passed to you from another listener.

Note: The address for the audio stream will **not** normally be the same as the web page from which you access the stream on your PC.

2. Use the 'My added stations' link in the 'My account' area on the web site. This allows you to add details of new stations or to modify those already added. You can provide a name for the radio station which will be shown on your radio. You must also provide the web address, location and format details.
3. Once you have Internet radio stations available in your My Added Stations list, you may play these stations from your Internet Radio. These stations will be available on your radio from the Internet radio menu item 'My Added Stations'.
4. It is possible to add the web addresses for audio streams which may not be playable by your radio. If you attempt to play such a stream, your radio will normally display an error message of some kind. The Roberts WM-202 can only play MP3, WMA and Real Audio streams.
5. To look at, modify or delete your added stations list on the web site, use the link 'My added stations' in the 'My account' area. To delete an added radio station, click on the icon with a heart and minus symbol.

Selecting favourite stations - Internet Radio

1. Press the **Menu** button to enter the main menu.
2. Rotate the **Select/Tuning** control until 'Station list' is highlighted on the display. Press and release the **Select/Tuning** control to enter the menu.
3. Rotate the **Select/Tuning** control until 'My Favourites' is highlighted on the display. Press and release the **Select/Tuning** control and your favourite stations list will appear on the display (set up as described on page 28).
4. Rotate the **Select/Tuning** control to highlight the required station and then press the control to confirm your selection.

The display will show 'Connecting...' while it finds the new station.

If the station has on-demand content (that is, it gives the option of listening to programmes which have already been broadcast), see page 23, 'Selecting a podcast / BBC Listen again'.

Should you be unable to connect to a particular station, please note that some radio stations do not broadcast 24 hours per day, and some stations are not always on-line.

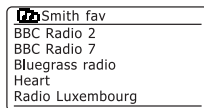
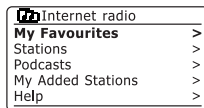
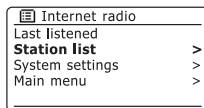
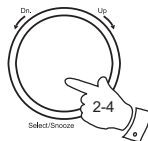

Selecting your added stations - Internet Radio

1. Press the **Menu** button to enter the main Internet Radio menu. Rotate the **Tuning/Select** control until 'Station list' is highlighted on the display. Press the **Tuning/Select** control to select.
2. Rotate the **Tuning/Select** control until 'My Added Stations' is highlighted on the display. Press the **Tuning/Select** control to select.
3. Rotate the **Tuning/Select** control to highlight the required station and then press the control to confirm your selection.
The display will show 'Connecting...' while it finds the new station.

Should you be unable to connect to a particular station, please note that some radio stations do not broadcast 24 hours per day, and some stations are not always on-line.

In addition, as mentioned on page 26, it is possible to specify audio streams for 'My added stations' which are not compatible with your radio. In this event the station will not be playable. The Roberts WM-202 can only play MP3, WMA and Real Audio streams.

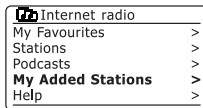
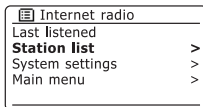
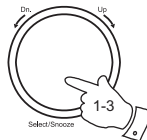

Media Player

The Media Player allows you to play audio files which are stored on a computer on your network. Supported file formats are MP3 and WMA. Note that the playback of DRM protected content and WMA Lossless files is not supported.

Your radio supports two file access methods. It can connect to folders shared on the network, commonly known as Windows Shares. It can also connect with file server applications using the Universal Plug and Play (UPnP) protocol. It is generally preferable to access your media files via a UPnP server application. This method offers normally simpler set up and superior file searching compared to the Shared Folders method.

When using Windows Shares, music selection is primarily by the folders in which the files are stored. You may then choose to play from a particular track within a folder. When using a UPnP server, the search and selection criteria are determined by the server, but typically include Artist, Album and Genre. Many server applications also allow you to access files according to the folders within which they are stored as well as other criteria.

If you are a Windows user, then it is very likely that your computer already has a UPnP server application available. Windows Media Player version 11 has this capability, and it is able to make your MP3 and WMA files available to your radio. It also allows you to search by Album, Artist, and so on as mentioned above. Many users will find this a more convenient method of playing their files compared to using shared folders. Both methods are described in this instruction manual.

Users of non-Windows computers (including Apple and Linux based devices) can also use Shared Folders or a UPnP server to make media available to the radio. However, it is beyond the scope of this instruction manual to cover all hardware and software environments. We explain the use of Microsoft's Windows Media Player since that will be the first choice for the majority of users.

Using Windows Shares

This section describes setting up your Windows PC to allow the radio to access your audio files via Windows Shares. If you wish to use UPnP, please turn to page 34.

1. Please ensure that your PC is accessible on the same network as your Internet radio. Then, using Windows Explorer, locate the folder where your audio files are stored.
2. Right click on the folder.
3. Select 'Properties'.
4. Click on 'Sharing'.
5. Select 'Share this folder on the network' and 'Allow network users to change my files'.

Please note, it is recommended that you do not try to make your 'My Documents' or any of its sub-folders (e.g. 'My Music') accessible as shares. This is because of the way that these special folders are managed within Windows.

In some cases, especially if you have a Windows PC using third-party security software (not supplied by Microsoft) it may be necessary to configure your computer's firewall software and / or network settings to permit file sharing. If this is necessary please refer to your computers software documentation for further information.

Locate the shared audio files using the radio

1. Press the **On/Off** button to switch the radio on. Then press the **Mode** button to select Music Player mode.
2. Press the **Menu** button to enter the main Music Player menu.
3. Rotate the **Tuning/Select** control until 'Shared folders' is selected on the display. Press the control to select.
4. The radio will then display a list of Workgroups or Domains that it has identified on your computer network. In most cases there will only be one item shown which will be the workgroup name for your home network. Rotate the **Tuning/Select** control if needed to point to the required workgroup or domain and then press the control to select.
5. The radio will then display a list showing the different computers on the network which are sharing files. Rotate the **Tuning/Select** control to point to the desired computer and then press to select. If your computer is not shown, check its file sharing and firewall settings.
6. Press the **Tuning/Select** control. The radio will then search the selected computer for shared folders. The radio is initially configured to be able to connect to a folder which has been shared on a PC running Windows with default security settings. If the radio connects, you will then see a list of folders in which your files are stored.

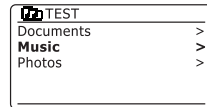
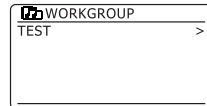
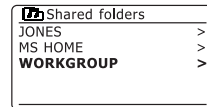
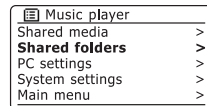
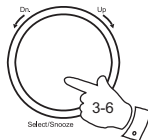

If the computer has specific user name and password security settings for access to shared folders, then you will need to set up a user name and password within your radio. See paragraph 8 on the next page for details on how to do this.

Locate the shared audio files - cont.

- If your computer has connected successfully to the shared folder, please skip to 'Media Selection' on page 38.
- To specify a user name and password for access to shared folders, press the **Menu** button. Using the **Tuning/Select** control scroll down to 'PC settings'. Use the **Tuning/Select control** to select 'PC settings'. You then have the ability to separately specify the user name and password.
- To change the user name, use the **Tuning/Select** control to choose 'User name' from the menu. The default user name in the radio is 'guest'. To change this, use the '[BKSP]' symbol or the **Back** button to delete it. Select and enter the characters for the required user name. Remember to use upper and lower case characters as needed. When the complete name is entered, use the '[OK]' symbol.
- To change the password, use the **Tuning/Select** control to choose 'Password' from the menu. The default password in the radio is blank. Select and enter characters for the required password. Remember to use upper and lower case characters as needed. When the complete name is entered, use the '[OK]' symbol.
- Once you have entered the user name and password for the folder from which you wish to play audio files, go back to paragraph 2 on the preceding page and re-enter the Music Player. You should now be able to access the folders successfully.
- If the user name and password are correct for your shared folders and the radio still cannot connect to your PC or its shared folders it is most likely that your PC's firewall software is blocking access (see 'Troubleshooting' on page 69).

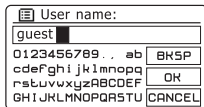
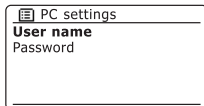
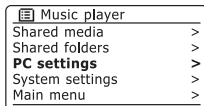

Accessing your audio files via a UPnP server

The recommended way to access your media files is via a UPnP server application. This method offers normally simpler set up and superior file searching compared to the Shared Folders method.

If your computer is running Windows (XP or Vista), then Windows Media Player version 11 includes a UPnP server which will make your files available to your radio. There are other UPnP server solutions available for Windows users who may wish to use an alternative.

If you use an Apple computer running a version of OS X then you may use a third party UPnP server application. Examples include EyeConnect and Twonky Media Server.

If you use a version of the Linux operating system, there are a range of UPnP server applications available.

It is beyond the scope of this instruction book to cover all possible options for UPnP. We explain the use of Microsoft's Windows Media Player since that will be the first choice for the majority of users.

Selecting Media Sharing in Windows Media Player 11



Set up UPnP access on a Windows PC

1. If your PC is running Microsoft Windows XP or Windows Vista then you can use Microsoft's Windows Media Player version 11 to act as your UPnP (Universal Plug and Play) media server. If not already installed on your PC, Windows Media Player 11 may be downloaded from Microsoft's web site and installed by following the instructions detailed in its installation wizard, or by using Microsoft's Windows Update facility.
2. Once installed, Windows Media Player 11 can create a library from all the media files available to it on your PC. To add new media files to the library, select 'File > Add to Library... > Advanced Options', click 'Add' and choose the files you wish to add and click 'OK'.

Set up UPnP access on a Windows PC - cont.

You will now need to connect your Internet radio to Windows Media Player 11 and configure it to allow access to your media library.

3. Press the **On/Off** button to switch the radio on. Then press the **Mode** button as needed until the 'Music Player' mode display is shown.. Press the **Menu** button to enter the main Music Player menu.
4. Rotate the **Tuning/Select** control until 'Shared media' is highlighted and press the control to select. The radio will scan for all available UPnP servers. It may take a few seconds for the radio to complete its scan. The radio will display '<Empty>' if no UPnP servers are found.
5. After scanning, select your UPnP server using the **Tuning/Select** control. If you are using WMP 11 as the server, your radio will then normally display 'Unauthorised - Select to retry' at this stage.
6. Your PC may prompt you that there has been a connection to your UPnP server. Whether prompted or not, to allow the radio to access the media files, you will need to click the 'Library' tab in WMP 11 and select the 'Media Sharing...' item to open the 'Media Sharing' window. Make sure the box 'Share my media to:' is ticked.
7. In the 'Media Sharing' window, the radio will be listed as an unknown device. Click on the unknown device shown to select it, then click the 'Allow' button and then click 'OK'.
Note: If you are using Microsoft Windows' firewall software, this should be correctly configured by WMP 11. If you are using third party firewall software you may need to manually configure it to allow your radio and WMP 11 to communicate (see 'Troubleshooting' on page 69).
8. On the radio, select the named server again using the **Tuning/Select** control. If WMP 11 is now able to communicate with your radio you will be presented with some media selection options on the display.

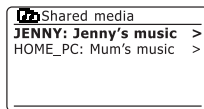
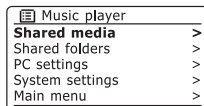
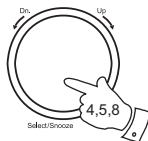

Allowing a device to connect to Windows Media Player 11

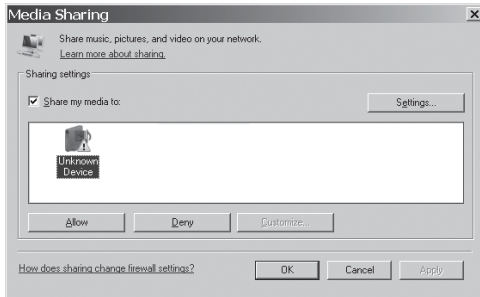

Locating and playing media files using UPnP

Once the UPnP server has been configured to share media files with your Internet radio, you may select the files that you wish to play as follows:-

1. Press the **On/Off** button to switch on the radio. Press the **Mode** button as needed until the 'Music Player' mode display is shown.
2. Press the **Menu** button to enter the main Music Player menu.
3. Rotate the **Tuning/Select** control until 'Shared media' is highlighted on the display.
4. Press the **Tuning/Select** control and the radio will scan for all available UPnP servers. Note that it may take a few seconds for the radio to complete its scan. The radio will display 'Empty' if no UPnP servers are found.
5. After a successful scan, rotate the **Tuning/Select** control to highlight your UPnP server and then press the **Tuning/Select** control. If the display shows multiple media types, select 'Music'. (Some UPnP servers can serve pictures and video content to suitable devices.)
6. The radio will now list the media categories which are made available by the UPnP server - for example, 'Album', 'Artist' and 'Genre'. Rotate the **Select** control to highlight which category you wish to browse, then press the **Select** control to confirm your choice.

If you wish to use the search function rotate the **Tuning/Select** control until 'Search' is selected on the display. You may select characters to build a keyword for searching for content to play.

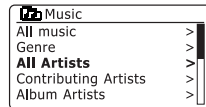
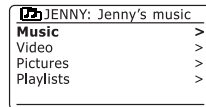
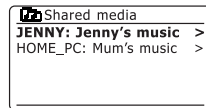
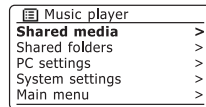
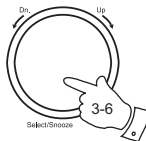

Note:

Do not worry if not all of your media appear in the menus immediately. Windows Media Player needs to look inside each file to identify the artist, album and track information from 'tags' embedded in each file. Additionally, Windows Media Player may take time to access the Internet to obtain additional information such as 'album art' which it can display when you examine your music library on your PC.

In UPnP mode the search criteria offered and the file types made available to the radio are a function of the UPnP server software installed on your PC. Such software can vary quite widely in its capabilities. Windows Media Player 11 has limited flexibility compared to some UPnP servers, but is generally easy to set up and reliable

Some third party server applications allow customisation of the search criteria and indexing methods, which can be useful if you have a very large collection of stored music files.

Many UPnP server applications are also capable of sharing pictures and video files to other network connected devices. If this is the case (as it is with Windows Media Player 11) you may see the option of choosing between 'Music', 'Video' and 'Pictures' on your radios menu. Clearly you should only select the 'Music' option. Content offered via the alternative options will not be playable on your radio.

Media selection

Whether you access your files using Shared folders or using UPnP, the file selection mechanisms are very similar.

When searching via UPnP you will have a selection of search criteria as determined by the UPnP server software on your computer. This allows you to search by a given information type (Album, Artist, etc.) and then to narrow the search to an album or to a particular track within an album.

When searching using Shared folders, the selection of files is determined by the folder structure in which you have the files stored on your computer. If you have a large library, this requires greater discipline in the allocation of folder names to represent artists and albums.

The searches described here are just examples of the possibilities.

Listening to a complete album

1. Use the **Tuning/Select** control to choose content by Artist, Album, folder, etc. according to your needs. Shared folder access will only allow you to search by folder name. Press the **Tuning/Select** control.
2. When you reach the album or folder the menu will then switch to showing the tracks in that album or folder. If searching by UPnP they will normally be listed in track number order. If searching by shared folders they will be listed in filename order.
3. With the first track in the album indicated, press the **Tuning/Select** control. The album will then begin playing.

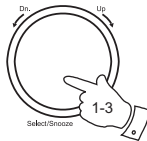

While the radio is playing from your media library, you may use the menus as described above to choose a different selection. When you select the track from which to play, the radio will then immediately begin playing the new selection.

Media Player

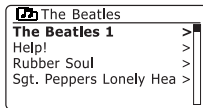
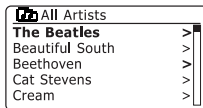
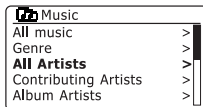
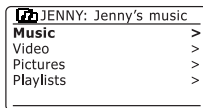

Listening to a particular track

1. If you wish to play only a particular track from an album or folder, first choose the album or folder as described on the preceding pages.
2. Rotate the **Tuning/Select** control until the required track is highlighted.
3. Press and release the **Tuning/Select** control. The track will begin playing. The radio will then play subsequent tracks from the same album or folder.

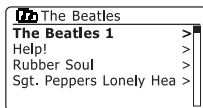
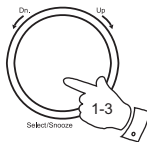

Controlling playback

1. Press the **Pause** button to pause playback of the current track.
2. If you press the **Play** button, playback will resume from the point where it was paused.
3. Press the **Rewind** button to start playback of the previous track in the list.
4. Press the **Fast-forward** button to start playback of the next track in the list.

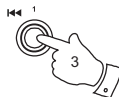
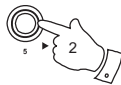

Display modes - Media Player

Your radio has a range of display options when in Media Player mode. Note that the availability of information depends on the specific media files and also upon the UPnP server capability (if used).

1. Press the **Info** button to cycle through the different options.
 - a. Artist Displays the artist information for the current track.
 - b. Album Displays the album information for the current track.
 - c. Format Displays the bit rate and format of the track currently being played.
 - d. Buffer Displays the radios internal buffer status during media playback.

Whenever the media player is displaying an information screen (as opposed to a menu screen), the time is displayed in the top-right corner of the display, and a WiFi strength or Ethernet connection indicator is shown in the bottom-right corner.

In addition, in the lower part of the display an indicator shows the method by which the radio is obtaining the media - either via UPnP, or via Shared Folders. In the latter case the symbol shows CIFS (Common Internet File System), a term sometimes used to describe how folders are shared across a network.

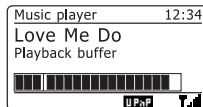
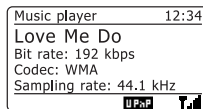

Operating your radio - DAB

1. Carefully extend the telescopic aerial.
2. Press the **On/Off** button to switch on the radio. If the radio has been used before the last used mode will be selected.
3. Press the **Mode** button as needed so that DAB mode is selected on the display.
4. If this is the first time that DAB mode is used a quick scan of the UK Band III DAB channels will be carried out. The display will show "Scanning".
If the radio has been used before the last used station will be selected.
5. During the scanning process, as new stations are detected the station counter will increase and stations will be added to the list of stations which is stored in the radio. The bar graph indicates the progress of the scan.
6. When scanning is completed the radio will tune to the first station (in numeric-alpha order 0....9...A...Z) unless it has previously been tuned to a DAB station.
7. If the station list is still empty after the scan your radio will display "Service not available".
8. If no stations are found it may be necessary to relocate your radio to a position giving better reception.

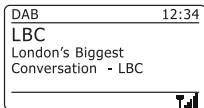
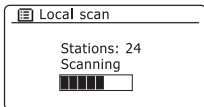

Selecting a station - DAB

1. The display normally shows the name of the currently tuned radio station.
2. Rotate the **Tuning/Select** control to access the radio station list and to scroll through the available stations.
3. Press the **Tuning/Select** control to select the highlighted station. The display may show 'Connecting...' while the radio re-tunes.
4. Use the **Volume** buttons to set the sound level as needed.



Note: If the display shows "Station Not Available" it may be necessary to relocate your radio to a position giving better reception.

A question-mark in front of the station name merely indicates that the station has not recently been detected by the radio. It may still be available.

The use of the radio station presets is described on page 54.

Secondary services - DAB

Some radio stations can have one or more secondary stations associated with them. Typically these are not broadcast continually. If a station has a secondary station available then the secondary will appear in the list of station names beneath the main (or primary) station. Examples are the programmes 'Daily Service' and 'Parliament' on BBC Radio 4.

1. To listen to a secondary service, use the **Tuning/Select** control to scroll to the chosen station, and press the control to tune to the station.

If the secondary service is not available (off-air) then the primary service will be selected.

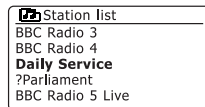
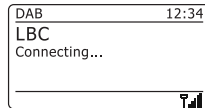
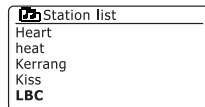
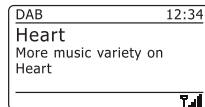
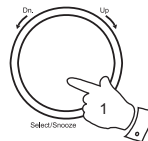

Display modes - DAB

Your radio has a range of display options when in DAB mode:-

1. Press the **Info** button to cycle through the different options.

a. Text

Displays text messages such as the artist or track name, phone in number, traffic alerts, etc.

b. Program Type

Displays the type of station being listened to such as Pop, Classic, News etc.

c. Multiplex Name / Frequency

Displays the name of the DAB multiplex and frequency to which the current station belongs.

d. Signal error / strength

Displays the signal error and strength for the station being listened to. A lower error number indicates a better quality of radio signal. The signal strength graph can be used when positioning the radio or its antenna.

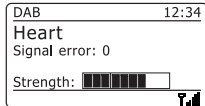
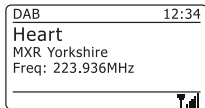
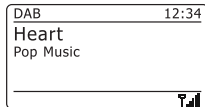
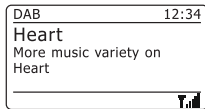

- e. Bit rate and audio type Displays the digital bit rate and audio type for the station being listened to
- f. Date Displays the current date.

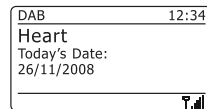
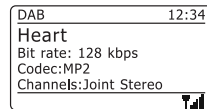

Finding new stations - DAB

Should you wish to use your radio for DAB reception in a new location, or if no stations were detected during the initial scan, you can follow this procedure to allow your radio to find out which DAB radio stations are available.

1. Ensure that the telescopic antenna is extended, and then press the **Mode** button as needed to select DAB mode.
2. Once in DAB mode press the **Menu** button.
3. Rotate the **Tuning/Select** control until 'Local scan' is highlighted on the display.
4. Press the **Tuning/Select** control to initiate the scan. The display will show 'Scanning' and your radio will perform a scan of the UK DAB frequencies. As new stations are found the station counter will increase and stations will be added to the list. The bar graph indicates the progress of the scan.
5. To carry out a full scan of the entire DAB band III frequencies rotate the **Tuning/Select** control until 'Full scan' is highlighted on the display.
6. Press the **Tuning/Select** control to initiate the scan. The display will show 'Scanning'. As new stations are found the station counter on the right hand side of the display will increase and stations will be added to the list. The bar graph indicates the progress of the scan.
Due to the larger number of DAB channels scanned, the full scan will take longer than the local scan.

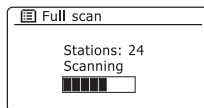
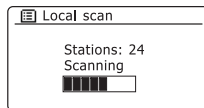
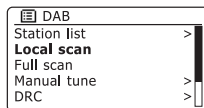
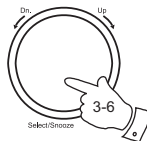

Manual Tuning - DAB

Manual tuning allows you to tune directly to the various DAB Band III channels. At the time of writing, all UK DAB stations are located in the range 11B to 12D.

1. When in DAB mode press **Menu** button so that the display shows the DAB menu list.
2. Rotate the **Tuning/Select** control until 'Manual tune' is highlighted.
3. Press the **Tuning/Select** button to enter manual tune mode.
4. Rotate the **Tuning/Select** control to choose the required DAB channel.
5. Press the **Tuning/Select** button to cause the radio to tune to the chosen channel.

When the radio has tuned, the display shows the channel number and frequency, and the name of the DAB multiplex found (if any).

A bar graph shows the signal strength and is useful if you need to reposition the radio or its aerial. The minimum signal marker 'I' which separates the left and right parts of the signal graph shows the minimum signal level required for satisfactory reception.

Any new radio stations found on the tuned DAB multiplex will be added to the list stored in the radio.

6. Press the **Menu** or **Back** button to choose a different frequency.
7. Press the **Menu** or **Back** button a second time to access the main DAB menu then select 'Station list' to return to normal tuning.

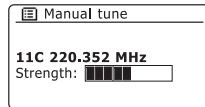
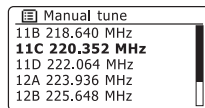
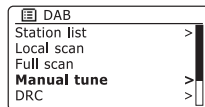
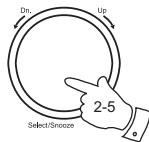
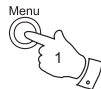

Dynamic Range Control settings - DAB

Dynamic Range Control (also known as DRC) can make quieter sounds easier to hear when your radio is used in a noisy environment by reducing the dynamic range of the audio signal.

1. Press the **On/Off** button to switch on your radio.
2. Press the **Mode** button as needed to select DAB mode.
3. Press the **Menu** button to enter the DAB menu list.
4. Rotate the **Tuning/Select** control until 'DRC' is highlighted on the display.
5. Press the **Tuning/Select** control to enter the DRC adjustment mode. The current DRC setting will be indicated with an asterisk.
6. Rotate the **Tuning/Select** control to highlight the required DRC setting (the default is Off).
DRC Off - DRC is switched off, Broadcast DRC will be ignored.
DRC high - DRC is set as sent by broadcaster.
DRC low - DRC level is set to 1/2 that sent by broadcaster.
7. Press and release the **Tuning/Select** button to confirm the setting.

Note: Not all DAB broadcasts use the DRC function. If the broadcast does not provide DRC information, then the DRC setting in the radio will have no effect.

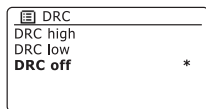
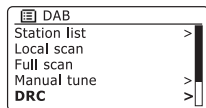
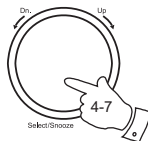
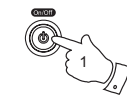

Station order setup - DAB

Your radio has 3 station order settings from which you can choose. The station order settings are, alphanumeric, ensemble and valid.

Note: The default station order on your radio is alphanumeric.

1. Press the **On/Off** button to switch on your radio.
2. Press the **Mode** button as needed to select DAB mode.
3. Press the **Menu** button to enter the DAB menu list.
4. Rotate the **Tuning/Select** control until 'Station order' is highlighted. Press the **Tuning/Select** control to enter the station order adjustment mode.
5. Rotate the **Tuning/Select** control to choose between Alphanumeric, Ensemble and Valid.
 - Alphanumeric sorts the station list alpha-numerically 0...9 A...Z.
 - Ensemble mode organises the station list by DAB multiplex.
 - Valid shows only those stations for which a signal can be found.
 The current setting is indicated by an asterisk.
6. Press the **Tuning/Select** control to select the required station order.
7. Press the **Menu** button as needed to return to the DAB menu or to the stations list.

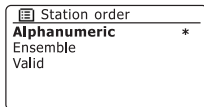
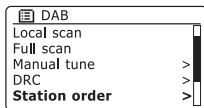
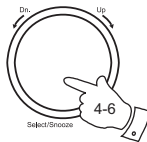

Operating your radio - FM

1. Carefully extend the telescopic aerial and press the **On/Off** button to switch on your radio.
2. Press the **Mode** button as needed to select the FM mode display.
3. Rotate the **Tuning/Select** control in a clockwise direction. The displayed frequency will increase. Press the **Tuning/Select** control to carry out an auto-tune. Your radio will scan up the FM band from the currently displayed frequency and will stop scanning when it finds a station of sufficient strength.
4. The display will show the frequency of the signal which has been found. If RDS information is available, after a few seconds the display will show the radio station name.
If you only hear hiss or interference, simply press the **Tuning/Select** control to scan further. Your radio may have found a spurious interference signal.
5. To find more FM stations press the **Tuning/Select** control to repeat the scan operation. To scan down in frequency, rotate the **Tuning/Select** control in a anti-clockwise direction first and then press the control. Your radio will scan down the FM band from the currently displayed frequency and will stop scanning when it finds a signal of sufficient strength.
6. When the end of the waveband is reached your radio will recommence tuning from the opposite end of the waveband.
7. Use the **Volume** buttons to adjust the sound level as needed.

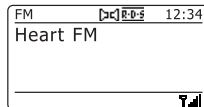
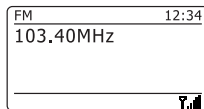
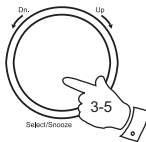

Manual tuning - FM

- Carefully extend the telescopic aerial and press the **On/Off** button to switch on your radio.
- Press the **Mode** button as needed to select the FM mode display.
- Rotate the **Tuning/Select** to control the frequency that the radio will tune to. The frequency will change in steps of 50kHz.
When the end of the waveband is reached the radio will recommence tuning from the opposite end of the waveband.
- Use the **Volume** buttons to adjust the sound level as needed.
- To switch off your radio press the **On/Off** button.

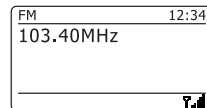
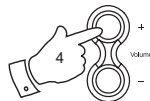
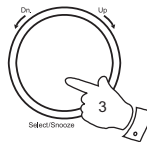

Display modes - FM

Your radio has a range of display options when in FM mode:-

1. Press the **Info** button to cycle through the different options.

- | | |
|-----------------|--|
| a. Text | Displays text messages such as the artist or track name, phone in number, traffic alerts, etc. |
| b. Program Type | Displays the type of station being listened to such as Pop, Classic, News etc. |
| c. Frequency | Displays the frequency of the FM signal. |
| d. Date | Displays the current date. |

Note: If no RDS information is available, then the radio will only be able to display the frequency. There will be no text or programme type information available under these conditions.

The radio only provides displays when there is information available. So if there is no text, for example, that display is not available.

The RDS indicator at the top of the display shows that there is some RDS data present in the broadcast being received.

The stereo speaker display shows that the radio is receiving a stereo broadcast (see also page 53 - 'Stereo/Mono switching')

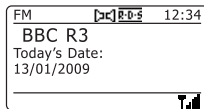
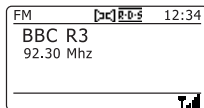
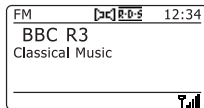
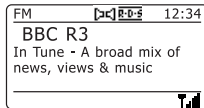

Scan setting - FM

When using the FM mode your radio can be set to either scan local stations or to scan all stations including distant radio stations.

1. Press the **Mode** button as needed to select the FM mode display.
2. Press the **Menu** button to enter the FM menu list.
3. Rotate the **Tuning/Select** control until 'Scan setting' is highlighted. Press the **Tuning/Select** control to enter the scan adjustment mode.
The current setting is indicated with an asterisk.
4. To set your radio so that only the stations with the strongest signals are found during scanning (normally local stations) rotate the **Tuning/Select** control until 'Yes' is highlighted. Press the **Tuning/Select** control to confirm the setting.

Alternatively, to set your radio so that all available stations are found during scanning (local and distant) rotate the **Tuning/Select** control until 'No' is highlighted. Press the **Tuning/Select** control to confirm the setting.

5. Press the **Menu** button to return to the normal FM mode display.

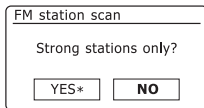
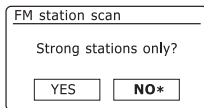
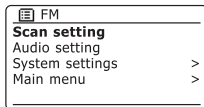
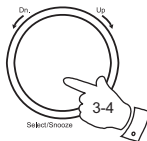

Stereo / Mono switching - FM

If the FM radio station being listened to has a weak signal, some hiss may be audible. It is possible to reduce this hiss by forcing the radio to play the station in mono rather than stereo.

1. Press the **Mode** button as needed to select the FM mode display and tune to the required FM station as previously described.
2. Press the **Menu** button to enter the FM menu list.
3. Rotate the **Tuning/Select** control until 'Audio setting' is highlighted on the display. Press the **Tuning/Select** control to enter the audio setting mode.

The current setting is indicated with an asterisk.

4. To switch to mono in order to reduce the hiss from a weak FM signal rotate the **Tuning/Select** control until 'Yes' is highlighted. Press the **Tuning/Select** control to confirm the setting.

Alternatively, to return to the normal automatic 'stereo or mono' mode rotate the **Tuning/Select** control until 'No' is highlighted. Press the **Tuning/Select** control to confirm the setting.

5. Press the **Menu** button to return to the normal FM mode display.

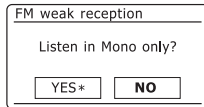
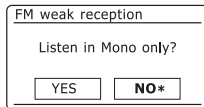
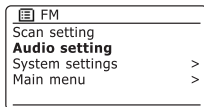
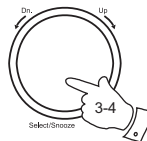

Presetting stations - DAB and FM radio

There are 5 memory presets each for DAB, FM and Internet radio. They are used in the same way for each operating mode.

1. Press the **On/Off** button to switch on your radio.
2. Tune to the required radio station as previously described.
3. To store the station as a preset, press and hold the required **Preset** button (1 - 5) until the display shows 'Preset stored'. The station will be stored under the chosen preset button. Repeat this procedure as needed for the remaining presets.
4. Stations which are already stored in the presets may be over written by following the above procedure.

Note: All the radio station presets are preserved in memory when the radio is switched off, even if there are no batteries installed.

Recalling a preset - DAB and FM radio

1. Press the **On/Off** button to switch on your radio.
2. Select the required operating mode using the **Mode** button.
3. Momentarily press the required **Preset** button. Your radio will then tune to the station stored in preset memory. The chosen preset number is shown in the lower area of the radio display, e.g. 'P2'.

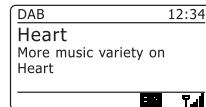
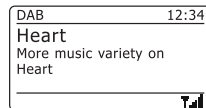

Automatically updating the clock

Your radio will normally update the clock automatically when connected to the internet. If you enter a time setting manually, the radio will calculate a local time offset so that whenever it synchronises using the internet, the correct local time is stored in the radio. In the event of a power failure, your radio will connect to the internet and then set the clock automatically based on this information.

You may wish to use the radio away from the internet, in which case you may specify that the radio sets its clock from DAB or FM radio broadcasts. After a power failure the radio will then set its clock the next time that you turn on the radio in DAB or FM mode.

Alternatively you may specify that the time is not automatically updated. In this case the clock must always be set manually after a power interruption.

1. With your radio switched on, press the **Menu** button to access the menu for the current mode.
2. Rotate the **Tuning/Select** control until 'System settings' is highlighted on the display. Press the control to enter the system settings menu.
3. Rotate the **Tuning/Select** control until 'Time/Date' is highlighted on the display. Press the control to enter the time setup.
4. Rotate the **Tuning/Select** control until 'Auto update' is highlighted on the display. Press the control to enter the auto-update menu.
5. Rotate the **Tuning/Select** control to choose an update option from 'Update from DAB', 'Update from FM', 'Update from Network' or 'No update' as required. Press the control to confirm your choice. The radio will then exit to the previous menu display.

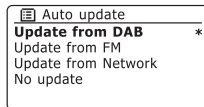
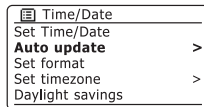
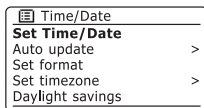
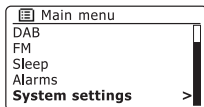
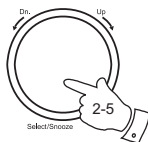
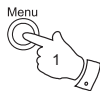

Setting the clock format

The clock display used in stand-by mode and on the playing mode screens can be set to 12 or 24 hour format. The selected format is then also used when setting the alarms.

1. With your radio switched on, press the **Menu** button to access the menu for the current mode.
2. Rotate the **Tuning/Select** control until 'System settings' is highlighted on the display. Press the control to enter the system settings menu.
4. Rotate the **Tuning/Select** control until 'Time/Date' is highlighted on the display. Press the control to enter the time setup.
5. Rotate the **Tuning/Select** control until 'Set format' is highlighted on the display. Press the control to enter the clock format menu.
The current clock display format is marked with an asterisk.
6. Rotate the **Tuning/Select** control to select either 12 or 24 hour format. Press the control to confirm your choice of clock format. The display will then revert to the previous menu.

If the 12 hour clock format is chosen, the radio will then use the 12 hour clock for the setting of alarms, and will display a 12 hour clock with an AM or PM indicator when in stand-by mode.

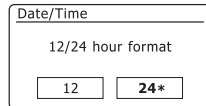
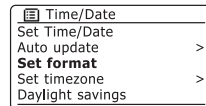
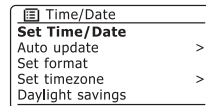
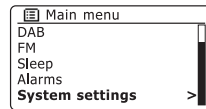
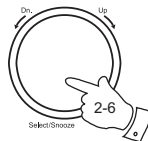

Manually setting the clock

The WM-202 Internet radio will normally set its clock automatically to UK time after a connection to the Internet has been established. Should you need to set the time manually, change the time zone, or manually switch from winter to summer time (GMT to BST - also known outside the UK as daylight savings time), then please follow this procedure.

1. Press the **On/Off** button to switch on your radio.
2. Access the main menu by pressing the **Menu** button until the 'Main menu' option is shown, then select this with the **Tuning/Select** control.
3. Rotate the **Tuning/Select** control until 'System settings' is highlighted on the display. Press the control to enter the system settings menu.
4. To change the time zone setting go to step 11.
To change from winter to summer time go to step 13.
To change the current time or date setting rotate the **Tuning/Select** control until 'Time/Date' is highlighted on the display, then press the control to enter the time and date setting screen.
5. Rotate the **Tuning/Select** control until 'Set Time/Date' is highlighted on the display. Press the control to enter the clock setup. The day digits will flash.
6. Rotate the **Tuning/Select** control until the correct day is shown on the display. Press the control to enter the selection. The month digits will then flash.
7. Rotate the **Tuning/Select** control to select the correct month. Press the control to enter the selection. The year digits will then flash.

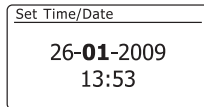
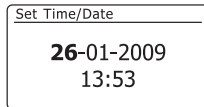
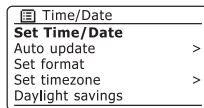
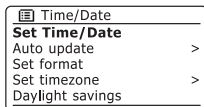
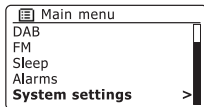

- Rotate the **Tuning/Select** control to select the correct year. Press the control to enter the selection. The hour digits will then flash.
- Rotate the **Tuning/Select** control to select the correct hour. Press the control to enter the selection. The minute digits will then flash.
- Rotate the **Tuning/Select** control to select the correct minutes. Press the control to enter the selection. The display will then return to the previous menu.
Press the **Menu** button to exit or go to step 11 to set the time zone.

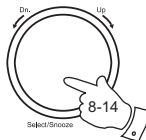

- Rotate the **Tuning/Select** control until 'Set timezone' is highlighted on the display then press the control.
- Rotate the **Tuning/Select** control to highlight the time zone which is applicable to your location, then press the control to confirm the setting.
Press the **Menu** button to exit or go to step 13 to set the summer / winter time option.

- Rotate the **Tuning/Select** control until 'Daylight savings' is highlighted on the display then press the control. The asterisk shows the current setting.
In the UK, ON is equivalent to British Summer Time, OFF is equivalent to Greenwich Mean Time.

- Rotate the **Tuning/Select** control to highlight 'ON' or 'OFF' as required then press the control to confirm the setting.
- Press the **Menu** button to exit.

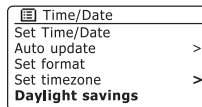
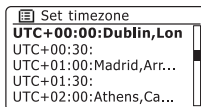
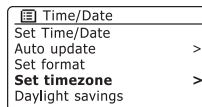
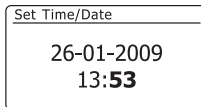
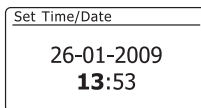
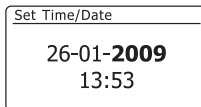

Setting the alarm clock

Your radio has two separate alarms which can be set to wake you to either the radio or a buzzer alarm. In the event of a power interruption your radio has built in memory that will retain your alarm settings.

Ensure that the time is set correctly before setting the alarms.

IMPORTANT: Your radio must be powered from the mains supply in order for the clock to run so that the alarms will operate. You cannot use the alarms if the radio is only running from batteries.

1. With your radio switched on, press the **Menu** button to access the menu for the current mode. Rotate the **Tuning/Select** control until 'Main menu' is highlighted on the display. Press the control to enter the main menu.
2. Rotate the **Tuning/Select** control until 'Alarms' is selected on the display. Press the control to see the current alarm settings. If no change is required, press the **Menu** or **Back** buttons to exit.
3. Rotate the **Tuning/Select** control until the desired alarm (1 or 2) is highlighted on the display. Press the control to enter alarm setup.
4. Rotate the **Tuning/Select** control until 'Time' is highlighted on the display. Press the control to adjust the alarm time.
5. Rotate the **Tuning/Select** control to choose the alarm hour. Press the control to confirm the setting.
6. Rotate the **Tuning/Select** control to choose the alarm minute. Press the control to confirm the setting. The display will then return to the alarm setting menu.

If the radio has been set to use a 12 hour clock format, there will also be an option here for setting AM or PM for the alarm time.

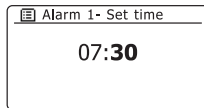
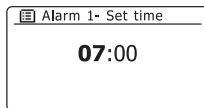
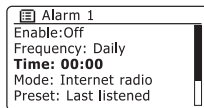
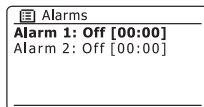
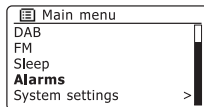
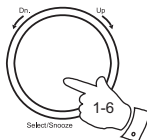
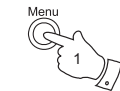

7. Rotate the **Tuning/Select** control to highlight the Frequency option for the alarm then press the control if you wish to change it. The alarms options are as follows:

Daily - the alarm will sound everyday

Once - the alarm will sound once

Weekdays - the alarm will sound on weekdays only

Weekends - the alarm will sound only at weekends

Rotate the **Tuning/Select** control to choose the required alarm frequency option. Press the control to confirm the selection.

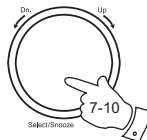

8. Rotate the **Tuning/Select** control to highlight 'Enable:'. Press the control to alternately switch between On and Off. Press the control until 'Enable: On' shows on the display. Choosing Off will disable the alarm.

9. The alarm can be set to buzzer, Internet radio, DAB radio or FM radio. For whichever radio mode is selected, the radio alarm may be set to any of the stations which have been stored as presets or to the station most recently listened to.

Rotate the **Tuning/Select** control to highlight the current Mode option for the alarm, then press the control if you wish to change it.

Rotate the **Tuning/Select** control to highlight either buzzer or the required radio mode. Press the control to confirm the selection.

10. If setting the alarm to a radio option, rotate the **Tuning/Select** control to highlight the 'Preset:' option then press the control if you wish to change it.

Choose from either the radio station 'Last listened' to, or from the presets 1 - 5. Scroll to the chosen option and press the control to confirm the selection. Note that you can only set the alarm to use a preset which has already been stored.

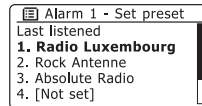
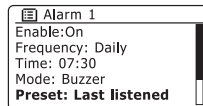
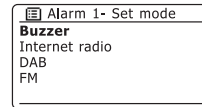
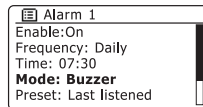
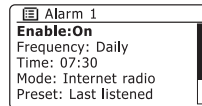
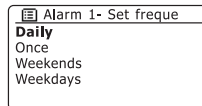
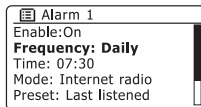

11. Rotate the **Tuning/Select** control until the 'Volume:' option is highlighted on the display and press the control if you wish to change it. The radio uses the saved volume setting for each alarm when it sounds.

Rotate the control to set the required volume and then press the control to confirm the setting.



12. In order to store the alarm settings rotate the **Tuning/Select** control until 'Save' is highlighted. Press the control to store the alarm settings. Your radio will show 'Alarm saved' and will then go back to the list of alarms with the new alarm setting shown in the display.

If you decide not to save the settings, press the **Back** button. The display will show 'Save changes' with a YES or NO option. Rotate the **Tuning/Select** control to choose 'NO' and then press the control. 'Alarm not saved' will show on the display.

Active alarms are shown using small alarm indicators at the bottom of the playing displays and on the clock display when in stand-by.

Note: If you make a mistake at any point while setting the alarms, use the **Back** button to go back to the previous screen.

When the alarm sounds

The buzzer or radio alarm will sound at the selected times for up to 60 minutes unless cancelled. The volume used for the alarm will be as specified during the alarm setting procedure. If the radio cannot connect to the specified radio station, the buzzer alarm will be used instead.

To cancel an alarm, press the **On/Off** button to return to stand-by mode.

The alarm icon will flash at the bottom of the playing mode displays, and the radio will automatically switch back to stand-by mode when the 60 minutes have elapsed.

Note: If the radio is switched on because of an alarm you can still control basic functions such as volume and selecting presets. You cannot perform operations which involve the Select control since this also acts as the Snooze button (see page 62).

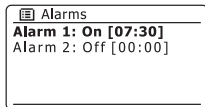
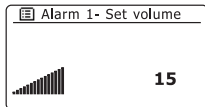
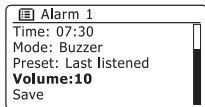

Disabling alarms

1. To disable a single alarm enter the alarm setup menu (see page 59) and rotate the **Tuning/Select** control until the desired alarm is highlighted on the display. Press the **Tuning/Select** control.
2. Rotate the **Tuning/Select** control until the 'Enable:' option is highlighted on the display.
3. Press and release the **Tuning/Select** control to change the status so that the display shows 'Enable: Off'.
4. Rotate the **Tuning/Select** control until the 'Save' option is highlighted on the display then press the control to save the new setting.
The chosen alarm will now be disabled.

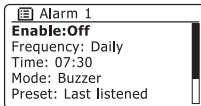
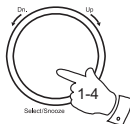

Snooze timer

1. The buzzer or radio alarm can be silenced for 5 minutes by pressing the **Tuning/Select/Snooze** control. Should you wish for a longer snooze duration this can be extended. Pressing the control again while the radio is snoozed will set the available snooze time to 5, 10, 15 or 30 minutes.
2. While the snooze timer is active the remaining snooze time is shown next to the flashing alarm icon on the clock display.
3. In order to cancel the Snooze timer, press the **On/Off** button. The display will briefly show an 'Alarm Off' message.

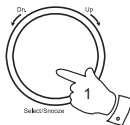

Sleep timer

Your radio can be set to turn off after a preset time has elapsed. The sleep timer setting can be adjusted between 15 and 120 minutes in 15 minute increments.

1. Press the **On/Off** button to switch on your radio.
2. Access the menu for the current mode by pressing the **Menu** button. Rotate the **Tuning/Select** control until 'Main menu' is highlighted on the display. Press the control to enter the main menu.
3. Rotate the **Tuning/Select** control until 'Sleep' is highlighted on the display then press the **Tuning/Select** control.
4. Rotate the **Tuning/Select** control until the required sleep time setting is selected. Press the **Tuning/Select** control to confirm the setting. The sleep timer can be set to between 15 and 120 minutes, or to Off.

5. Your radio will switch into stand-by mode after the preset time has elapsed. If running on batteries it will switch off completely shortly afterwards.

An active sleep timer is shown using a small timer indicator at the bottom of the playing displays. This indicator also shows the sleep time remaining before the radio switches itself into stand-by mode.

6. To cancel the sleep time before the preset time has elapsed and to turn off the radio, press the **On/Off** button to turn the radio off manually.

To cancel the sleep timer and leave the radio playing, go back into the sleep timer settings (steps 1 to 4 above) and select the Off option in step 4. Alternatively, simply press the **On/Off** button twice in succession to cancel the timer and switch the radio back on again.

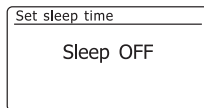
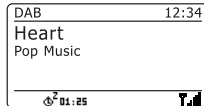
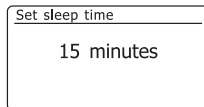
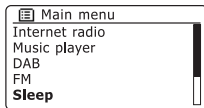
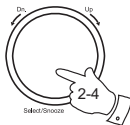

Brightness control

The brightness of the display can be adjusted for when the radio is in Stand-by and for when it is in use. If you use the unit in the bedroom, you may prefer a lower stand-by brightness level than the standard setting. There are three brightness levels and an off setting.

1. Press the **On/Off** button to switch on your radio. Access the menu for the current mode by pressing the **Menu** button.
2. Rotate the **Tuning/Select** control until 'System settings' is highlighted on the display. Press the control to enter the system settings menu. Rotate the **Tuning/Select** control until 'Brightness' is highlighted on the display. Press the control.
3. To adjust the display brightness when the radio is switched on rotate the **Tuning/Select** control until 'Active' is highlighted on the display. To adjust the display brightness when the radio is in stand-by rotate the **Tuning/Select** control until 'Standby' is highlighted. Press the control to enter the selected brightness adjustment mode.
4. To adjust the brightness level rotate the **Tuning/Select** control clockwise to increase the brightness level and anti-clockwise to decrease it. The backlight level will change as the control is rotated so that you can see the effect of each setting. Note that the backlight is completely off at the zero setting. Press the control to confirm the setting. Press the **Menu** button to exit.

When the radio is in Stand-by mode, pressing a button or turning the rotary control will cause the radio to switch to the Active brightness level for a few seconds. If the Stand-by brightness level is set to zero (backlight off), it is still possible to see the time at night by quickly pressing a button.

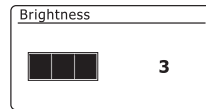
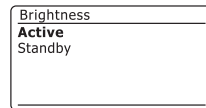
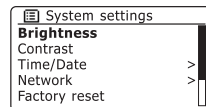
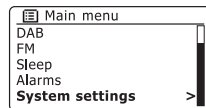
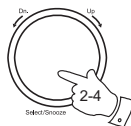

Contrast / viewing angle control

The contrast of the display can be adjusted. The adjustment also changes the angle from which the display can best be seen.

1. Access the menu for the current mode by pressing the **Menu** button. Rotate the **Tuning/Select** control until 'System settings' is highlighted on the display. Press the control to enter the system settings menu.
2. Rotate the **Tuning/Select** control until 'Contrast' is highlighted on the display and press the control.
3. Rotate the **Tuning/Select** control to adjust the contrast and viewing angle. The contrast level indication on the screen will change at the same time. When you find the setting that gives the best legibility for the location in which the radio is used, press the control to confirm the setting.
4. Press the **Menu** button to exit.

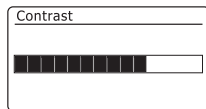
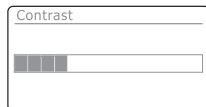
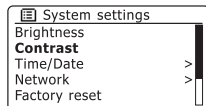
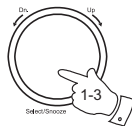
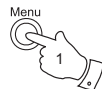

Headphone socket

A 3.5mm **Headphone Socket** located on the rear of your radio is provided for use with headphones. Inserting a plug automatically mutes the internal loudspeaker.

Please be aware that the sensitivity of headphones can vary widely. We therefore recommend setting volume to a low level before connecting headphones to the radio.

IMPORTANT: Excessive sound pressure from earphones and headphones can cause hearing loss.

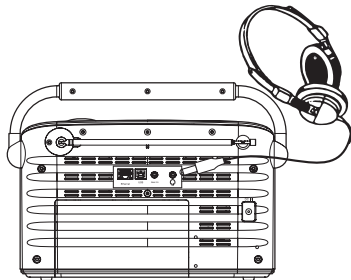

Auxiliary input socket

A 3.5mm **Auxiliary Input** socket located on the rear of your radio is provided for connecting the audio signal from an external audio source such as an MP3 or CD player.

1. Connect a stereo lead from the headphone output of your MP3 or CD player to the Aux In socket. Typically this lead will have a 3.5mm stereo plug at both ends.
2. Switch on your radio and turn the volume **on the radio** to minimum.
3. Press 'play' on the connected audio device and adjust the volume using its volume control, leaving the radio's volume at minimum.
4. After use, disconnect your player in order to listen to your radio conventionally.

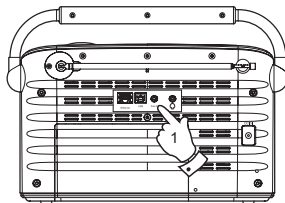

Factory reset

If you wish to completely reset your radio to its initial state this may be performed by following this procedure. By performing a factory reset, all user entered settings will be erased.

1. Access the main menu by pressing the **Menu** button until the 'Main menu' option is shown, then select this with the **Tuning/Select** control.
2. Rotate the **Tuning/Select** control until 'System settings' is selected on the display. Press the control to enter the system settings menu.
3. Rotate the **Tuning/Select** control until 'Factory Reset' is selected on the display then press the control. Rotate the **Tuning/Select control** and highlight 'YES' to proceed.

If you do not wish to carry out a system reset, highlight 'NO' and then press the control. The display will revert to the previous menu.

4. With 'YES' highlighted, press the **Tuning/Select** control. A full reset will be performed. The station list together with any preset stations will be erased and your wireless network connection details will be lost. All configuration settings will be restored to their defaults, the clock and alarms will be reset.

In case of malfunction for any reason, reset the product as described above to resume normal operation. It may be necessary in some cases to disconnect the mains power and remove the batteries, then reconnect power after 10 seconds.

In case of malfunction due to electrical fast transient (burst), reset the product as above (reconnection of the power source may be required) to resume normal operation.

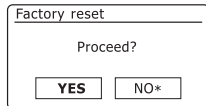
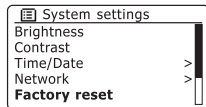
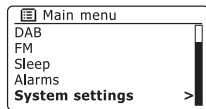
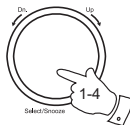

From time to time, new software features for your radio may be developed. Your radio has therefore been designed to allow its internal software to be updated using your Internet connection.

You should not attempt to update your radio unless it is recommended to you by Roberts Customer Services. Updating the software may remove all network settings, radio station presets and alarm settings from your radio.

It is important that you do not attempt this procedure unless you have a good Internet connection and a reliable mains power supply. If the radio connects to your router using a WiFi connection, make sure that this is also reliable before proceeding.

1. The 'Software update' option is accessed via the System settings menu. When you select 'Software update' the radio will display 'Auto check setting' and 'Check now'. If you want your radio to check periodically for new software versions rotate the **Tuning/Select** control to highlight 'Auto check settings'. Then press the control and select 'Yes'. If you do not want your radio to check for updates select the 'No' option.
2. To check if there are any software updates available currently, rotate the **Tuning/Select** control to highlight 'Check now' and then press the control. The radio will check to see if an update is available. The display will show 'Checking for new versions'. If there are no updates then the display will show 'Software up to date'. If a software update is available your radio will then offer the choice of updating the software or not, displaying 'New version available. Update software?'. Select the 'Yes' option if you wish to go through the update process.
3. If you choose to update your radio it will first download the new software and will then reprogram its internal memory. This may take a few minutes depending on the speed of your internet connection.
4. Once the software update is completed, the radio will prompt you to press **Select** to restart. Press the **Tuning/Select** control and your radio will then restart. You may find that you will need to reconfigure your network connection following an update. You may also need to re-enter all radio station presets, alarm settings, and configuration options.

VERY IMPORTANT: Do not switch off the power to the radio until the update operation is complete and the radio has restarted, otherwise the radio may become permanently damaged.

If you need any further advice, please call our Technical Helpline on 020 8758 0338 (Mon-Fri)

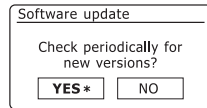
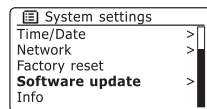
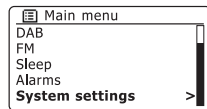

Network profiles

Each time that you connect your radio to a WiFi network, the radio will store the details of that connection (SSID, security key, DHCP/IP address settings) as a profile. Up to four such profiles are stored in the radio so that if your radio is frequently used in multiple locations there is no need to enter the network settings when returning to a location previously visited.

The radio stores the four most recent profiles in memory identified by their SSID. Normally the radio will attempt to connect to one of the stored profiles and only if it is unable to do so will you need to use the Network Wizard (see page 13).

In the event that you visit a location only once you may wish to delete the profile for the network in that location to avoid losing other profiles.

1. Access the menu for the current mode by pressing the **Menu** button. Rotate the **Tuning/Select** control until 'System settings' is highlighted on the display. Press the control to enter the system settings menu.
2. Rotate the **Tuning/Select** control until 'Network' is highlighted on the display. Press the control to enter the Network menu.
3. Rotate the **Tuning/Select** control until 'Network profile' is highlighted on the display. Press the control to see the stored profiles. The profile currently in use (if any) is marked with an asterisk.
4. To remove a profile from memory, rotate the **Tuning/Select** control to highlight the profile to be deleted and then press the control.
5. The radio will offer a 'Yes' or 'No' selection. Rotate the control to select 'Yes' and then press the control. The selected profile will be deleted.

Note that it is not possible to delete a profile which is currently in use.

Troubleshooting

If you experience any trouble with your Internet radio, then you may find it useful to visit the help section on our web site at

http://www.robertsradio.co.uk/pages/wm202_faqs.htm

If you have difficulty connecting the radio to your computer network, some of these steps may help to resolve the problem:

1. Confirm that a WiFi connected PC can access the Internet (i.e. can browse the web) using the same network.
2. Check that a DHCP server is available (normally a router function), or that you have configured your radio to use DHCP. Your radio will by default use DHCP. This may be configured using the menu items 'Main Menu' -> 'System settings' -> 'Network' -> 'Manual settings'. This will ask first whether you wish to configure a wired or a wireless connection. For either wired or wireless you then need to choose 'DHCP enable' or 'DHCP disable'. If you enable DHCP then the radio will negotiate with your router (or DHCP server) and will be provided with an IP address as well as the other settings needed. If you wish to set the network configuration manually, refer to paragraph 6.
3. Check that your network's firewall is not blocking any outgoing ports. As a minimum, the radio needs access to UDP and TCP ports 80 and 123. Port 53 may be required for DNS. Some Internet radio services may require additional ports to be open. The use of Windows Shares requires access to UDP and TCP ports 135 - 139 and 445. Windows Media Player 11 will allocate a port number for UPnP media sharing and will configure Microsoft's Windows built-in firewall appropriately. Other firewall software may require configuration for UPnP or to allow particular IP addresses to have trusted access.
4. Check that your access point does not restrict connections to particular MAC addresses (sometimes called MAC address filtering).

You can view the radio's MAC address using the menu items 'Main Menu' -> 'System settings' -> 'Network' -> 'View settings' -> 'MAC address'. Note that the WM-202 radio has both wired and wireless MAC addresses. These are identical except for the first two digits.

A wireless MAC address will typically be of the form

00 : 13 : E0 : xx : xx : xx

A wired MAC address will typically be of the form

02 : 13 : E0 : xx : xx : xx

- If you have an encrypted network, check that you have entered the correct encryption key into the radio. Remember that text-format WPA keys are case sensitive. If your radio displays 'Network error' when attempting to connect to an encrypted network, then please ensure that you enter the correct key for the network. If the problem persists, then you may need to re-check your network configuration.
- If you need to set up your radio's IP address manually, you will need to know low-level details of your network's configuration. Use the menu items 'Main Menu' -> 'System settings' -> 'Network' -> 'Manual settings' -> 'Wired' or 'Wireless' (as needed) -> 'DHCP disable'.

The radio will then prompt you in turn for the

Ethernet IP address

Ethernet Subnet mask

Ethernet Gateway address

Ethernet Primary DNS

Ethernet Secondary DNS

If you are setting up a wireless connection manually you will also need to enter the SSID, the encryption type, and the encryption key.

See page 14 for full details on how to set up your radio's network configuration manually.

If your radio can connect to the network successfully, but is unable to play particular internet radio stations, it may be due to one these causes:

- The station is not broadcasting at this time of the day (remember it may be located in a different time zone, and some stations do not broadcast all day).
- The station has reached the maximum allowed number of simultaneous listeners.
- The Internet connection between your radio and the server (often located in a different country) is slow. This could be due to internet congestion, either locally or at a distance.
- The station is not broadcasting any more. The database of radio stations that your radio connects to is frequently updated and checked but may not always be completely accurate.
- The radio station is broadcasting using an audio format which is not playable by your radio (although the WM-202 does play the most popular formats used by regular broadcasters).

Try using a PC to play the stream via the broadcaster's web site or via the radio station database web site at <http://www.wifiradio-frontier.com>. If you can play the station with a PC, it may be that the internet feed or local network connection is poor. However, some broadcasters (such as the BBC) provide different data streams for PC users and internet radio listeners, so this test is not always conclusive.

If you cannot play the station via your PC this may indicate that the problem is not necessarily due to your radio, but it could be your network, your internet connection, the broadcaster, or internet congestion.

Software version display

The software version display is provided for reference and customer support purposes and cannot be changed.

1. Access the menu for the current mode by pressing the **Menu** button. Rotate the **Tuning/Select** control until 'System settings' is highlighted on the display. Press the control to enter the system settings menu.
2. Rotate the **Tuning/Select** control until 'Info' is highlighted on the display. Press the control to display the software version and radio ID.
3. Press the **Menu** button to exit.

Audio FAQ

Your radio can access some audio help for Internet Radio use.

1. With your radio switched on and in the Internet Radio mode, press the **Menu** button. Rotate the **Tuning/Select** control until 'Station list' is highlighted on the display. Press the **Tuning/Select** control.
2. Rotate the **Tuning/Select** control until 'Help' is highlighted on the display. Press the **Tuning/Select** control to enter the Help menu.
3. Rotate the **Tuning/Select** control until 'FAQ' is highlighted. Press the control to display some frequently asked questions.
4. Rotate the **Tuning/Select** control to choose a question that suits your requirements and press the control to listen to the answer. Adjust the volume as needed.

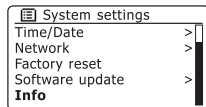
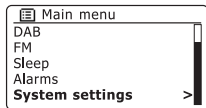
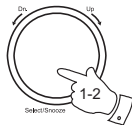

Cautions

Do not allow your radio to be exposed to water, steam or sand.
Do not leave your radio where excessive heat could cause damage.
The name plate is located on the rear of the radio.



- The radio shall not be exposed to dripping or splashing and no objects filled with liquids, such as vases, shall be placed on the radio.
- It is recommended to operate the product such that there is a minimum distance (10cm recommended) to adjacent objects in order to ensure good ventilation.
- The ventilation of the product should not be restricted by covering it with items such as newspapers, tablecloths, curtains etc.
- No naked flame sources such as lighted candles should be placed on the product.
- It is recommended to avoid using or storing the product at extremes of temperature. Avoid leaving the unit in cars, on window sills, in direct sunlight etc.
- The radio must be used in a moderate climate.

Specifications

Power Requirements

Mains	100-230 volts AC, 50Hz  only (use only supplied adaptor)
Batteries	6 x LR20 D size
Battery Life	35 - 50 hours approximately (using alkaline cells, listening 4 hours a day, depending upon operating mode)

Connectivity

Wired Ethernet	10M bits/sec via RJ-45
WiFi	802.11b and 802.11g supported with WEP and WPA/WPA2 encryption Compatible with 802.11n routers which offer mixed mode support for 802.11b/g

Circuit features

Loudspeaker	2 x 79 mm
Output Power	3 Watts RMS per channel
Headphone socket	3.5mm dia
Aux In socket	3.5mm dia
Aerial System	WiFi Built-in antenna DAB Telescopic aerial FM Telescopic aerial

The Company reserves the right to amend the specification without notice.

Software license information

This product is protected by certain intellectual property rights of Microsoft. Use or distribution of such technology outside of this product is prohibited without a license from Microsoft.

In addition, end users shall:

- a. Refrain from modifying, translating, reverse engineering, decompiling, disassembling or using other means to discover the Source Code or otherwise replicate the functionality of the Client Code, except to the extent that this restriction is expressly prohibited by applicable law.
- b. Disclaim on behalf of Real Networks Inc. all warranties and conditions other than those set forth in this End User License, express and implied, including implied warranties or conditions of merchantability and fitness for a particular purpose; and effectively exclude all liability for indirect, special, incidental and consequential damages, such as lost profits.

Guarantee

This instrument is guaranteed for twelve months from the date of delivery to the original owner against failure due to faulty workmanship or component breakdown, subject to the procedure stated below. Should any component or part fail during this guarantee period it will be repaired or replaced free of charge.

The guarantee does not cover:

1. Damage resulting from incorrect use.
2. Consequential damage.
3. Receivers with removed or defaced serial numbers.

N.B. Damaged or broken aerials will not be replaced under guarantee.

Procedure:

Any claim under this guarantee should be made through the dealer from whom the instrument was purchased. It is likely that your Roberts' dealer will be able to attend to any defect quickly and efficiently but should it be necessary the dealer will return the instrument to the Company's service department for attention. In the event that it is not possible to return the instrument to the Roberts' dealer from whom it was purchased, please contact Roberts Radio Technical Services at the address shown overleaf.

These statements do not affect the statutory rights of a consumer.

ROBERTS RADIO TECHNICAL SERVICES

97-99 Worton Road
Isleworth
Middlesex
TW7 6EG

Technical Helpline :- 020 8758 0338 (Mon-Fri during office hours)

Web site: <http://www.robertsradio.co.uk>

